

Programming Manual

C4, C4X

4-Channel SCR Power Controller with Independent PID Control

Software Version 1.01



PK548
0037-75571
June 2018

Table of Contents

Introduction.....	2
FIELD OF USE.....	2
Prohibited use.....	2
CHARACTERISTICS OF PERSONNEL	2
STRUCTURE OF THIS MANUAL	3
Communications.....	4
SERIAL COMMUNICATION (MODBUS).....	5
C4-compatible mode (dip-switch-7 =ON).....	5
C4 mode (dip-switch-7=OFF).....	5
CONNECTION.....	5
Installation of the “MODBUS” serial network.....	5
Inputs	6
MAIN INPUT	6
Probes and sensors.....	6
Scale limits	7
Setting the offset	7
Read state	7
Input filters.....	8
Linearization of input signal.....	8
- Signals from sensors.....	10
- Signals coming from custom thermocouples	11
CT AUXILIARY INPUT (Ammeter).....	12
Scale limits	13
Setting the offset	13
Read state	13
Input filter.....	13
Input sampling interval.....	13
VOLTAGE VALUE ON THE LOAD (Voltmeter)	14
Scale limits	15
Setting the offset	15
Read state	15
Input filter.....	15
AUXILIARY ANALOG INPUT (LIN/TC).....	16
Scale limits	17
Setting the offset	17
Read state	17
Input filter.....	17
DIGITAL INPUTS	18
Read state	18
Functions related to digital inputs	18
USING A FUNCTION ASSOCIATED WITH DIGITAL INPUT AND VIA SERIAL.....	19
USING A FUNCTION OF DIGITAL INPUT 1 TO ENABLE AT SOFTWARE ON.....	20
Alarms	21
GENERIC ALARMS AL1, AL2, AL3 and AL4.....	21
Reference variables	22
Alarm setpoints.....	22
Alarms hysteresis	22
Alarm type	23
Limits of absolute alarm settings.....	23
Enable alarms	24
Reset memory latch.....	24
Read state	24

LBA ALARM (Loop Break Alarm).....	26
Enable alarm.....	26
Read state	26
HB ALARM (Heater Break Alarm).....	26
Enable alarm.....	27
Alarm setpoints.....	28
Read state	28
ALARM SBR - ERR (probe in short or connection error)	29
Enable alarm.....	29
Read state	29
C4 with 4 TA	30
C4 with 1 TA	30
POWER FAULT ALARMS (SSR SHORT, NO_VOLTAGE, SSR_OPEN and NO_CURRENT)	
C4TERMO4 with 4 TA.....	30
Read state	31
OVERHEAT ALARM.....	31
OUTPUTS	32
Allocation of reference signals.....	32
Read state	34
Allocation of physical outputs	35
Read state	35
SETTINGS.....	37
SETTING THE SETPOINT	37
Local setpoint	37
Remote setpoint	37
Shared settings.....	37
Read active setpoint.....	37
SETPOINT CONTROL.....	38
Set gradient.....	38
Multiset	38
CONTROLS	40
PID HEAT/COOL CONTROL	40
Control actions	40
Proportional, derivative, and integral action.....	40
Heat/cool control with separate or superimposed band.....	40
Heat/cool control with relative gain	41
PID Parameters	41
Read state	42
AUTOMATIC / MANUAL CONTROL.....	44
HOLD FUNCTION	44
MANUAL POWER CORRECTION	44
MANUAL TUNING.....	45
AUTOTUNING	46
Read state	47
SELFTUNING	48
Read state	49
SOFTSTART	49
Read state	50
START MODE.....	50
SOFTWARE SHUTDOWN	50
Read state	50

Specialized Control Functions	51
FAULT ACTION POWER	51
Read state	51
POWER ALARM	51
SOFTSTART FOR PREHEATING	53
Read state	53
HEATING OUTPUT (Fast cycle).....	53
POWER CONTROL	54
SSR CONTROL MODES	54
HEURISTIC Control power	54
HETEROGENEOUS power control	55
VIRTUAL INSTRUMENT CONTROL	56
HW/SW INFORMATION	58
INSTRUMENT CONFIGURATION SHEET.....	64
PROGRAMMABLE PARAMETERS	64

ATTENTION!

This manual is an integral part of the product, and must always be available to operators.

This manual must always accompany the product, including if it is transferred to another user.

Installation and/or maintenance workers **MUST** read this manual and precisely follow all of the instructions in it and in its attachments. Chromalox will not be liable for damage to persons and/or property, or to the product itself, if the following terms and conditions are disregarded.

The Customer is obligated to respect trade secrets. Therefore, this manual and its attachments may not be tampered with, changed, reproduced, or transferred to third parties without Chromalox's authorization.

Important Safeguards

⚠ WARNING

HIGH VOLTAGE (up to 480 VAC) is used in the operation of this equipment; DEATH ON CONTACT may result if personnel fail to observe safety precautions.

Learn the areas containing high-voltage connections when installing or operating this equipment.

⚠ WARNING

Be careful not to contact high-voltage connections when installing or operating this equipment.

Before working inside the equipment, turn power off and ground all points of high potential before touching them.

⚠ CAUTION

The owner/installer must provide all necessary safety and protection devices and follow all current electrical wiring standards and regulations. Failure to do so may compromise the integrity of the controller and/or cause product failure resulting in a safety risk to operational and service personnel.

⚠ CAUTION

This controller utilizes a heat sink which is designed to cool the unit during operation. Under no circumstance should air flow around the controller be compromised in any way. Failure to do so may result in the overheating of the controller, product failure, product temperatures and even fire.

⚠ WARNING

During continuous operation, the heat sink can reach very high temperatures, and keeps a high temperature even after the unit is turned off due to its high thermal inertia.

Higher voltages may be present. DO NOT work on the power section without first cutting out electrical power to the panel. Failure to do so may cause serious injury or death.

⚠ WARNING

ELECTRIC SHOCK HAZARD: Any installation involving control equipment must be performed by a qualified person and must be effectively grounded in accordance with the National Electrical Code to eliminate shock hazard.

Introduction

The C4 Family of PID & power controllers are the C4, C4-IR, and C4X. This Programming Manual offers great application flexibility thanks to the extended configurability and programmability of its parameters.



This manual covers the C4 and C4X products. For the C4-IR please consult that Programming Manual.

Configuration and programming is accomplished by connecting the C4 or C4X to a PC which is equipped with the Chromalox C-PWR configuration software program. Connection between the PC and the controller MUST be done with a specific USB to TTL (or USB to RS485 adaptor cable supplied by Chromalox). Since it is impossible to foresee all of the installations and environments with which the instrument may be applied, adequate technical preparation and complete knowledge of the instrument's potentials are necessary.



Chromalox declines all liability if instructions for proper installation, configuration, and/or programming are disregarded, as well as all liability for systems upstream and/or downstream of the instrument.

Field of Use

The C4 Family is an ideal solution for many applications including multizone Ovens, Heat Treatment Furnaces, Thermoformers, Packaging Machinery, Food Processing Equipment, Semiconductor Equipment, Plastics Processing Equipment, and specialty loads such as IR Emitters, Silicon Carbide elements or transformers.



Chromalox declines all liability for damage of any type deriving from installations, configurations, or programmings that are inappropriate, imprudent, or not conforming to the technical data supplied.

The C4 Family is highly programmable and flexible. The C4 Family can also be used for other applications provided they are compatible with the instrument's technical data. Application and use of the C4 Family of products must always conform to the limits specified in the technical data supplied.

Prohibited Use

It is absolutely prohibited:

- to utilize the instrument or parts of it (including software) for any use not conforming to that specified in the technical documentation supplied;
- to modify working parameters inaccessible to the operator, decrypt or transfer all or part of the software;
- to utilize the instrument in explosive atmospheres;
- to repair or convert the instrument using non-original replacement parts;
- to utilize the instrument or parts of it without having read and correctly understood the technical documentation supplied;
- to scrap or dispose of the instrument in normal dumps; components that are potentially harmful to the environment must be disposed of in conformity to the regulations of the country of installation.

Characteristics of Personnel

This manual is intended for technical personnel, who commission the instrument by connecting it to other units, and for service and maintenance personnel. It is assumed that such persons have adequate technical knowledge, especially in the fields of electronics and automation.

The instrument described in this manual may be operated only by personnel who are trained for their assigned task, in conformity to the instructions for such task and, specifically, to the safety warnings and precautions contained in such instructions.

Thanks to their training and experience, qualified personnel can recognize the risks inherent to the use of these products/systems and are able to avoid possible dangers.

Structure of this Manual

This manual was originally written in ITALIAN. Therefore, in case of inconsistencies or doubts, request the original manual or explanations from Chromalox.

The instructions in this manual do not replace the safety instructions and the technical data for installation, configuration and programming applied directly to the product or the rules of common sense and safety regulations in effect in the country of installation.

For easier understanding of the controller's basic functions and its full potentials, the configuration and programming parameters are grouped according to function and are described in separate chapters.

Each chapter has from 1 to 3 sections:

- the first section presents a general description of the parameters described in detail in the following zones;

- the second section presents the parameters needed for the controller's basic applications, which users and/or installers can access clearly and easily, immediately finding the parameters necessary for quick use of the controller;
- the third section (ADVANCED SETTINGS) presents parameters for advanced use of the controller: this section is addressed to users and/or installers who want to use the controller in special applications or in applications requiring the high performance offered by the instrument.

Some sections may contain a functional diagram showing interaction among the parameters described;

- terms used on other pages of the manual (related or supplemental topics) are shown in underlined italics and listed in the index (linked to IT support).

In each section, the programming parameters are shown as follows:

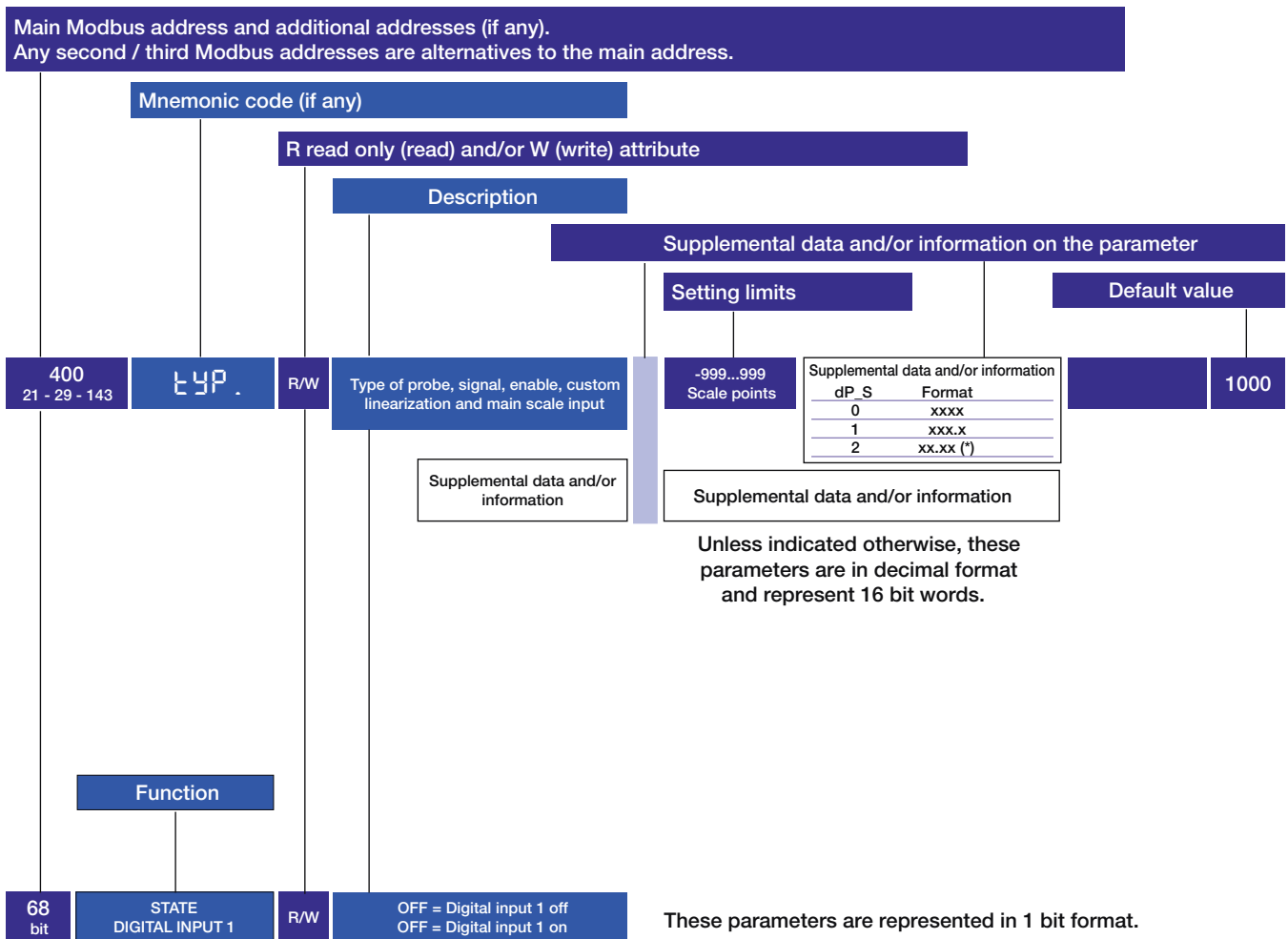

Communications

The modular power controller's flexibility permits replacement of previous-version instruments without changing the control software in use.

Based on the chosen work mode (see MODBUS SERIAL COMMUNICATION), you can use the instrument in 2 different modes:

- C4 Compatible mode
- C4 mode

New shared parameters, identified with Modbus addresses higher than 600, are accessible for both modes and permit more advanced functions such as:

604	FLT.2	R/W	Digital Filter for Auxiliary Input	0.0...20.0 sec	0.1
-----	-------	-----	------------------------------------	----------------	-----

In addition to having a CUSTOM group of parameters for dynamic addressing, C4 mode lets you use a single communication network node in-stead of 4 nodes as in Compatible mode.

NOTE! When programming, keep in mind that the addresses (parameters) described in this manual exist 4 times, specified by address node (ID).

C4 Compatible Mode Diagram

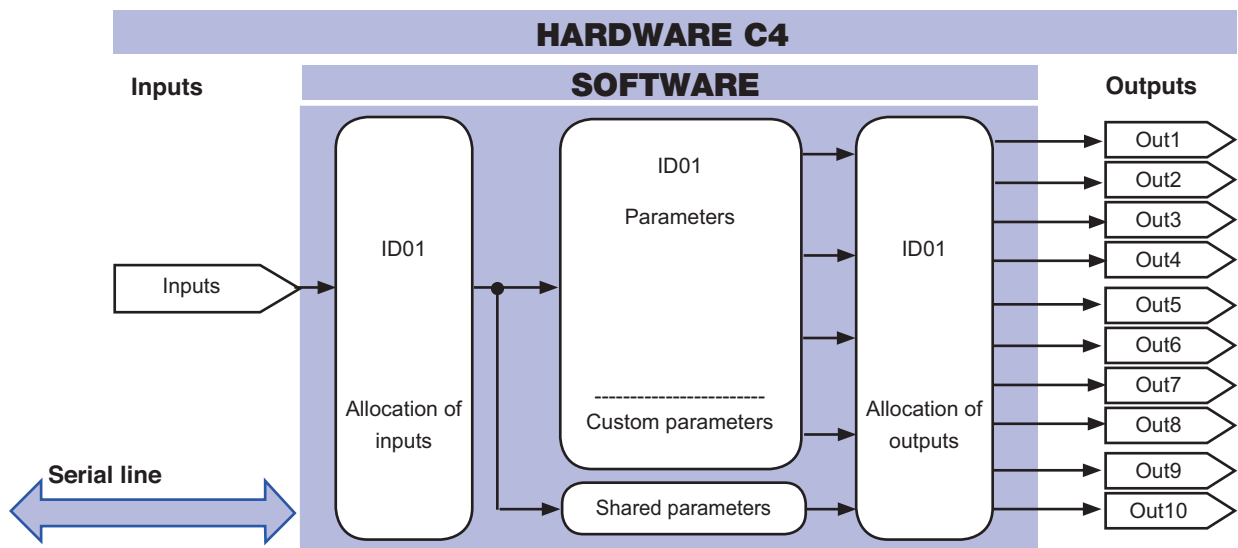
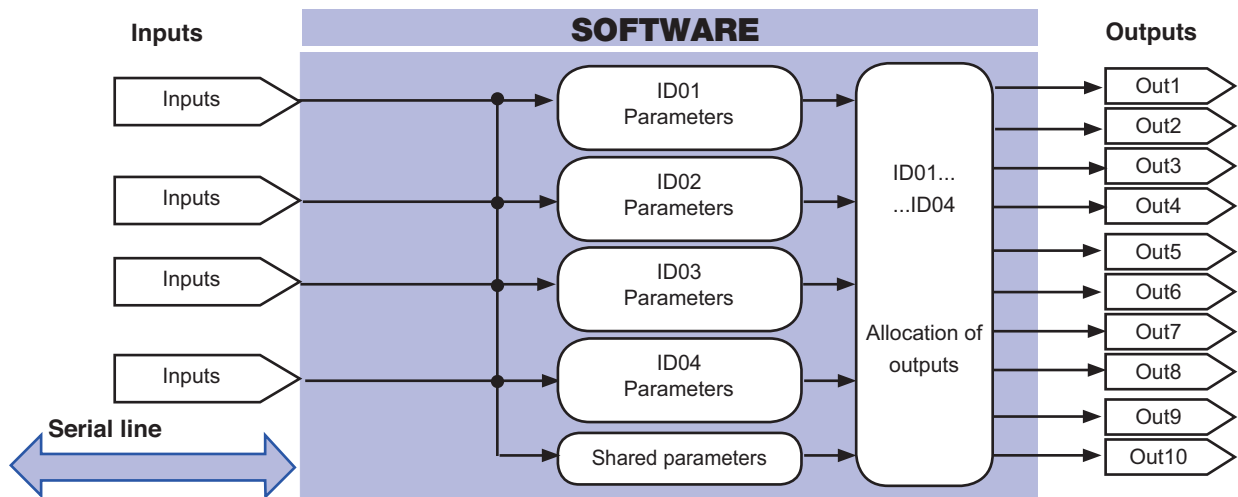

Serial Communication (Modbus)

There are two Modbus addressing modes for variables and configuration parameters:

- C4 compatible mode
- C4

The modes are selected with dip-switch-7.

C4 Compatible Mode (Dip-Switch—ON)

This lets you use supervision programs created for C4 modules.

Memory is organized into 4 groups:

- Zone 1
- Zone 2
- Zone 3
- Zone 4

In each zone, the variables and parameters have the same address as a C4 instrument; the value (Cod) set on the rotary switches corresponds to that of Zone 1; the values in the other zones are sequential. Shared word parameters for the C4 instrument have addresses starting at 600. Shared bit parameters have addresses high than 80.

Examples:

If the rotary switches have value 14, node 14 addresses Zone 1, node 15 Zone 2, node 16 Zone 3, node 17 Zone 4. The process variable (PV) for Zone 1 has address Cod 0. The PV for Zone 2 has address Cod+1, 0, etc... Parameter out.5, which defines the function of output OUT 5 on the C4, has address Cod 611.

C4 Mode (Dip-Switch—OFF)

This lets you optimize the efficiency of serial communication by integrating 4 zones in the C4. Memory is organized into 5 groups: 4 already in C4-compatible mode, plus one group defined as custom:

- Custom (additional memory map for dynamic addresses)
- Zone 1
- Zone 2
- Zone 3
- Zone 4

The custom group contains variables and parameters for a maximum of 120 words. The meaning of these words can be changed.

There is a single value (Cod) set on the rotary switches; i.e., one for each C4 instrument. To access the data in each zone, simply add an offset to the address (+1024 for Zone 1, +2048 for Zone 2, +4096 for Zone 3, +8192 for Zone 4). Words in the custom group have addresses 0,...,119. The variables and parameters are defined by default. At addresses 200,...,319 we have words containing the value of the address of the corresponding variables or parameters. These addresses can be changed by the user, offering the ability to read/write data with multi-word messages structured according to various supervision requirements.

NOTE: Protection of Maps 1-2.

You have to write the value 99 on addresses 600 and 601 to enable change of the custom group (addresses 200... 319). This value is reset at each switch-on.

Examples:

You can access the PV variable in Zone 1 with address Cod, 0+1024 or address Cod, 0 custom variable 1 (address Cod, 200 has value 1024); you can access the PV variable in Zone 2 with address Cod, 0+ 2048 or address Cod, 29 custom variable 30 (address Cod, 229 has value 2048); if you want to read the 4 process variables in sequence at the first 4 addresses, set Cod, 200 = 1024, Cod.201 = 2048, Cod,202 = 4096, Cod,203 = 8192.

Connection

Each C4 has an optically isolated serial port RS485 (PORT 1) with standard Modbus protocol via connectors S1 and S2 (type RJ10). Connector S3 is suitable for direct connection to a slave module or to a C4-OP operator terminal. Remember that the maximum communication speed of these devices is 19200 baud. You can insert a serial interface (PORT 2). There are various models based on the field bus required: Modbus, Profibus DP, CANopen, DeviceNet and Ethernet.

This communication port (PORT 2) has the same Cod address as PORT 1. The parameters for PORT 2 are bAu.2 (select baud-rate) and Par.2 (select parity).

The Cod parameter (read only) shows the value of the node address, settable from 00 to 99 with the 2 rotary switches; the hexadecimal settings are reserved. A parameter can be read or written from both communication ports (PORT 1 and PORT 2).

⚠ WARNING

Changing the bAu (select baud-rate) and/or PAr (select parity) parameters may cause communication failure.

To set the bAu and PAr parameters, you have to run the Autobaud procedure described in the "Instruction and warnings" manual.

Run the Autonode procedure for the Slave node parameter. For the Master, simply switch off and then back on.

Installation of the "MODBUS" Serial Network

A network typically has a Master that "manages" communication by means of "commands" and Slaves that interpret these commands. C4's are considered Slaves to the network master, which is usually a supervision terminal or a PLC. They are positively identified by means of a node address (ID) set on the rotary switches (tens + ones). C4's have a ModBus serial (Serial 1) and optional Fieldbus (Serial 2) serial (see order code) with one of the following protocols: ModBus, Profibus, CANopen, DeviceNet, Ethernet.

The following procedures are required for the Modbus protocol.

For the remaining protocols, see the specific Profibus, CANopen, DeviceNet and Ethernet manuals.

C4 modules have the following default settings:

- node address = 0 (0 + 0)
- speed Serial 1 = 19,200 bit/s
- parity Serial 1 = none
- speed Serial 2 = 19,200 bit/s
- parity Serial 2 = none

You can install a maximum of 99 C4 modules in a serial network, with node address selectable from “01” to “99” in standard mode, or create a mixed C4 network in C4 compatible mode in which each C4 identifies 4 zones with sequential node address starting from the code set on the rota-ry switches.

In short, the valid rotary switch settings (tens + ones) are:

- (0 +0) = Autobaud Serial 1
- (B +0) = Autobaud Serial 2
- (A + 0) = Autonode Serial 1 for slave modules connected to C4.

46	Cod	R	Instrument Identification Code	1 ... 99	
45	bAu	R/W	Select Baudrate – Serial 1	Baudrate Table	4
				bAud	Baudrate
				0	1200 bit/s
				1	2400 bit/s
				2	4800 bit/s
				3	9600 bit/s
				4	19200 bit/s
				5	38400 bit/s
				6	57600 bit/s
				7	115200 bit/s
47	PAr	R/W	Select Parity – Serial 1	Parity Table	0
				_Par	Parity
				0	No Parity
				1	Odd
				2	Even
626	bAu.2	R/W	Select Baudrate – Serial 2	See Baudrate Table	4
627	PAr.2	R/W	Select Parity – Serial 2	See Parity Table	0

Inputs

Main Inputs

The modular power controller has 4 main inputs to control 4 temperature zones, to which you can connect temperature sensors (thermocouples and RTD), linear sensors or custom sensors to acquire process variable (PV) values. To configure, you always have to define the type of probe or sensor (tYP), the maximum and minimum scale limit (Hi.S – Lo.S) for the process variable value, and the position of the decimal point (dP.S).

If the sensor is a thermocouple or resistance thermometer, the minimum and maximum limits can be defined on the specific scale of the sensor. These limits define the width of the proportional control band and the range of values settable for the setpoint and alarm setpoints.

There is a parameter to correct the offset of the input signal (oF.S): the set value is algebraically added to the read of the process variable.

You can read the state of the main input (Err) in which an input error is reported: when the process variable goes beyond the upper or lower scale limit, it assumes the value of the limit and the corresponding state reports the error condition:

Lo = process variable < minimum scale limit

Hi = process variable > maximum scale limit

Err = Pt100 in short circuit and input value below minimum limit,

4...20mA transmitter interrupted or not powered

Sbr = Tc probe interrupted or input value above maximum limit

If noise on the main input causes instability of the acquired value, you can reduce its effect by setting a low pass digital filter (Flt). The default setting of 0.1sec is usually sufficient. You can also use a digital filter (FId) to increase the apparent stability of the process variable PV; the filter introduces a hysteresis on its value: if the input variation remains within the set value, the PV value is considered unchanged.

400	tYP	R/W	Probe Type, signal, enable, custom linearization and main input scale
-----	-----	-----	---

Maximum error of non linearity for thermocouples (Tc), resistance thermometer (PT100)

Tc Type:		
J, K		error < 0.2% f.s.
S, R	range 0...1750°C:	error < 0.2% f.s. (t > 300°C)
	For other ranges:	error < 0.5% f.s.
T		error < 0.2% f.s. (t > -150°C)

And inserting a custom linearization

E,N,L		error < 0.2% f.s.
B	range 44...1800°C;	error < 0.5% f.s. (t > 300°C)
	range 44.0...999.9;	error f.s.(t>300°C)
U	range -200...400;	error < 0.2% f.s. (for t > -100°C)
	For other ranges;	error < 0.5% f.s.
G	error < 0.2% f.s. (t > 300°C)	
D	error < 0.2% f.s. (t > 200°C)	
C	range 0...2300;	error < 0.2% f.s.
	For other ranges;	error < 0.5% f.s.
JPT100 and PT100		error < 0.2% f.s.

The error is calculated as deviation from theoretical value with % reference to the full-scale value expressed in degrees Celsius (°C).

Table of probes and sensors

TC SENSOR				
Type	Type of probe	Scale	Without Decimal Point	With Decimal Point
0	TC J	°C	0/1000	0.0/999.9
1	TC J	°F	32/1832	32.0/999.9
2	TC K	°C	0/1300	0.0/999.9
3	TC K	°F	32/2372	32.0/999.9
4	TC R	°C	0/1750	0.0/999.9
5	TC R	°F	32/3182	32.0/999.9
6	TC S	°C	0/1750	0.0/999.9
7	TC S	°F	32/3182	32.0/999.9
8	TC T	°C	-200/400	-199.9/400.0
9	TC T	°F	-328/752	-199.9/752.0
28	TC	custom	custom	custom
29	TC	custom	custom	custom
SENSOR: RTD 3-wires				
Type	Type of probe	Scale	Without Decimal Point	With Decimal Point
30	PT100	°C	-200/850	-199.9/850.0
31	PT100	°F	-328/1562	-199.9/999.9
32	JPT100	°C	-200/600	-199.9/600.0
33	JPT100	°F	-328/1112	-199.9/999.9
SENSOR: RTD 3-wires				
Type	Type of probe	Scale	Without Decimal Point	With Decimal Point
34	0...60 mV	Linear	-1999/9999	-199.9/999.9
35	0...60 mV	Linear	Custom linearization	Custom linearization
36	12...60 mV	Linear	-1999/9999	-199.9/999.9
37	12...60 mV	Linear	Custom linearization	Custom linearization
SENSOR: 60mV voltage				
Type	Type of probe	Scale	Without Decimal Point	With Decimal Point
38	0...20 mA	Linear	-1999/9999	-199.9/999.9
39	0...20 mA	Linear	Custom linearization	Custom linearization
40	4...20 mA	Linear	-1999/9999	-199.9/999.9
41	4...20 mA	Linear	Custom linearization	Custom linearization
SENSOR: 20mA current				
Type	Type of probe	Scale	Without Decimal Point	With Decimal Point
42	0...1 V	Linear	-1999/9999	-199.9/999.9
43	0...1 V	Linear	Linear Custom	Linear Custom
44	200 mv..1 V	Linear	-1999/9999	-199.9/999.9
45	200 mv..1 V	Linear	Custom linearization	Custom linearization
SENSOR: 1V voltage				
Type	Type of probe	Scale	Without Decimal Point	With Decimal Point
46	Cust. 20mA	-	-1999/9999	-199.9/999.9
47	Cust. 20mA	-	Custom linearization	Custom linearization
48	Cust. 60mV	-	-1999/9999	-199.9/999.9
49	Cust. 60mV	-	Custom linearization	Custom linearization
50	PT100-JPT	-	custom	custom
99	Input off			

403	dP . 5	R/W	Decimal Point for Input Scale	Decimal Point Table	0
Specifies the number of decimal figures used to represent the input signal value: for example, 875.4 (°C) with dP.S = 1				dP_S	Format
				0	XXXX
				1	XXX.X
				2	XX.XX(*)
				3	X.XXX(*)
				(*) Not available for TC, RTD Probes	

Scale Limits

401	Lo . 5	R/W	Minimum scale limit of main input	Min...Max scale of input selected in tyP	0
Engineering value associated to minimum level of the signal generated by the sensor connected to the input: for example 0 (°C) with type K thermocouple					
402	hi . 5	R/W	Maximum scale limit of main input	Min...Max scale of input selected in tyP	1000
Engineering value associated to maximum level of the signal generated by the sensor connected to the input: for example 1300 (°C) with type K thermocouple					

Setting the Offset

519 23	oFS	R/W	Offset Correction for Main Input	-999...999 scale points	0
Lets you set a value in scale points that is algebraically added to the value measured by the input sensor.					

Read State

0 470	P.V	R	Read of engineering value of process variable (PV)		
85	Err	R	Self-diagnostic error code of main input	Error Code Table	
<p>For custom linearization (tYP = 28 or 29):</p> <ul style="list-style-type: none"> - LO is signaled with input values below Lo.S or at minimum calibration value. - HI is signaled with input values above Lo.S or at maximum calibration value. 				0	No Error
				1	Lo (process variable value is < Lo.S)
				2	Hi (process variable value is > di Hi.S)
				3	ERR [third wire interrupted for PT100 or input values below minimum limits (ex.: for CT with connection error)]
				4	SBR (probe interrupted or input values beyond maximum limits)

Advanced Settings

Input Filters

24	FLE	R/W	Low pass Digital Filter on Input Signal	0.0...20.0 sec	0.1
Sets a low pass digital filter on the main input, running the average value read in the specified time interval. If = 0 exclude the average filter on the sampled values.					
179	FLd	R/W	Digital filter on oscillations of input signal	0 ... 9.9 scale points	0.5
Introduces a hysteresis zone on the input signal value within which the signal is considered unchanged, thereby increasing its apparent stability.					

Linearization of Input Signal

The modular power controller lets you set a custom linearization of the signal acquired by the main input for signals coming from sensors and for signals coming from customer thermocouples.

Linearization is performed with 33 values (S00...S32: 32 segments).

S33, S34, S35 are an additional 3 values to be inserted in case of linearization with custom CT.

Signals from Sensors

For signals coming from sensors, linearization is done by dividing the input scale into 32 zones of equal dV amplitude, where:

$$dV = (\text{full-scale value} - \text{start of scale value}) / 32$$

Point 0 (origin) corresponds to the engineering value attributed to the minimum value of the input signal. Subsequent points correspond to the engineering values attributed to input values equal to:

$$\text{Input value (k)} = \text{Minimum input value} + k * dV$$

Where k is the order number of the linearization point.

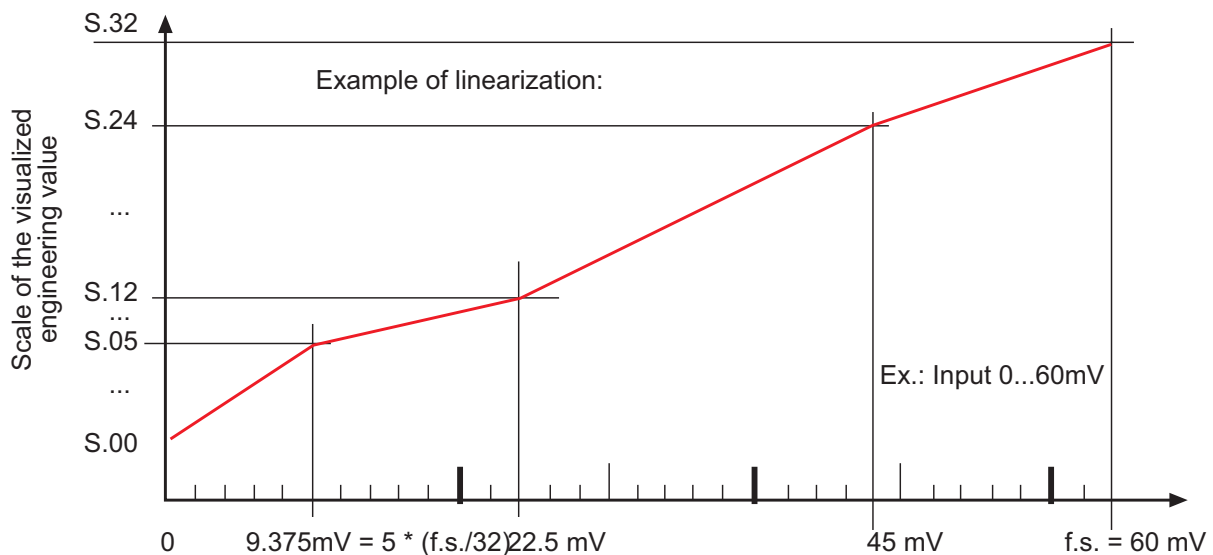

86	5.00	R/W	Engineering value attributed to Point 0 (min. value of input scale)	(- 1999 ... 9999)
87	5.01	R/W	Engineering value attributed to Point 1	(- 1999 ... 9999)
	...		Intermediate Values	
118	5.32	R/W	Engineering value attributed to Point 32 (max. value of input scale)	(- 1999 ... 9999)

Signals Coming from Custom Thermocouples

An alternate linearization is available only for sensors consisting of custom thermocouples, created by defining engineering values at three measurement scale points settable with the following parameters:

293	5.33	R/W	Engineering value attributed to mini-mum value of the input scale	mV start of scale (-19.99...99.99)
294	5.34	R/W	Engineering value attributed to maxi-mum value of the input scale.	mV full scale (-19.99...99.99)
295	5.35	R/W	Engineering value attributed to input signal corresponding to 50°C	mV at 50°C (-1.999...9.999)

Functional Diagram

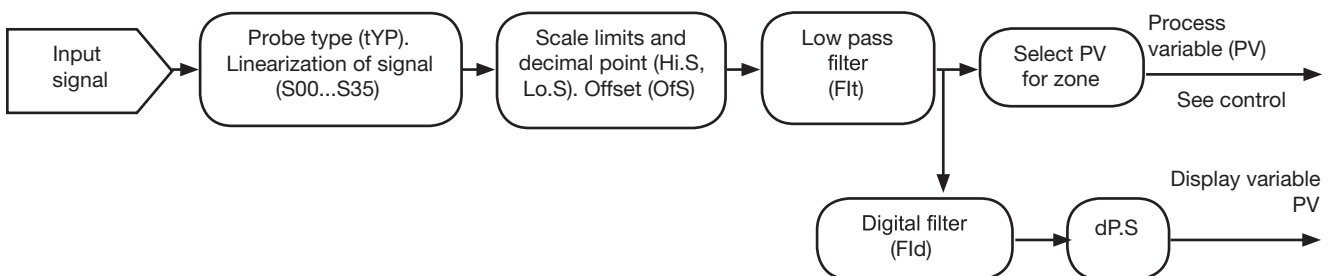

NOTE: The decimal point does not change the contents of the PV, but only permits its correct interpretation.
Ex. if dP.S = 1 and PV = 3—, the engineering val-ue in C is 30.0.

CT Auxiliary Input (Ammeter)

Optional input used to monitor current delivered to the load, both single phase and 3-phase, with automatic recognition of the internal ammeter transformer.

Models with 4 CT's (C4-x-x-2-x-x and C4-x-x-4-x-x) let you continuously acquire the current values circulating in the load with sampling interval of 60ms. The current value can be read in variable I.tA1 of each zone. If zone 1 has a 3-phase load, variables I.tA1, I.tA2 and I.tA3 in the first zone have the current value in line 1, line 2 and line 3, respectively.

You can also read the maximum current value corresponding to running state (ON) in variable I1on. This value is reset when no power is requested. In 3-phase load configuration, variables I1on, I2on and I3on in the first zone contain the current value in line 1, line 2 and line 3, respectively.

Models with 1 CT (C4-x-x-1-x-x and CX4-x-x-3-x-x) sample the load current value at a programmable time interval (parameter dG.t). Therefore, you can use the best sampling time for the application being run and, especially, for load type, since activation of the scan to identify faults on the load with fast systems and short cycle times may be critical for stable temperature control.

This works by having power to all 4 zones interrupted (control outputs = OFF), then, in succession, if the power requested exceeds a minimum settable value (dG.P), the individual zones activate to acquire the current value.

If there is current with the 4 zones OFF, the device is in SSR SHORT condition, but the faulty zone is not identified. If no current is detected with the zone ON (control output = ON), the device is in NO CURRENT condition, corresponding to a possible interrupted load or SSR open or no line voltage or blown fuse. If current flows, the sampled value is saved in variable I.tA1.

The 4 ammeter inputs are IN9, IN10, IN11, IN12, and the current value is found in variable I.tA1 for zones 1, 2, 3, 4, respectively.

If diagnostics identifies a fault on the load, the red ER LED starts to flash in sync with yellow LED O1 or O2 or O3 or O4 for the faulty zone.

The condition POWER_FAULT in OR with the HB alarm can be assigned to an alarm or can be identified in the state of a bit in the STA-TUS_INSTRUMENT, STA-TUS_INSTRUMENT_1, and STATUS_INSTRUMENT_2 variables.

In STATUS_INSTRUMENT_3, you can identify the condition that activated the POWER_FAULT alarm.

The POWER_FAULT diagnostics is configurable with parameter hd.2, with which you can also enable only one of its parts.

With models that have 4 CTs, you can diagnose the following single conditions:

- SSR SHORT: SSR module in short circuit;
- NO VOLTAGE: no line voltage or fuse blown or load interrupted;
- SSR OPEN: SSR module open ;
- HB: load partially interrupted.

With models that have 1 CT, you can diagnose the following conditions:

- SSR SHORT: SSR module in short circuit;
- NO CURRENT: load interrupted or SSR open or no line voltage or fuse blown;
- HB: load partially interrupted.

For a zone with single-phase load, the default value of the maximum limit or full scale of the current transformer (H.tA1) depends on the model, and equals 20.0A (30 kW model), 40.0A (60 kW model) or 60.0A (80 kW model). Parameters for correction of offset (o.tA1) and for the digital filter (Ft.tA) refer to the ammeter input.

If zone 1 has a 3-phase load, the following parameters are significant:

- I.tA1, I.tA2 and I.tA3: ammeter value on line L1, L2 and L3, respectively;
- I.AF1, I.AF2 and I.AF3: filtered ammeter value (see Ft.tA) on line L1, L2 and L3;
- I1on, I2on and I3on: current with control O1 on (ON) on line L1, L2 and L3;
- H.tA1, H.tA2 and H.tA3: maximum limit or full scale of current transformer on line L1, L2 and L3;
- o.tA1, o.tA2 and o.tA3 = offset correction for ammeter input on line L1, L2 and L3;
- Ft.tA = digital filter for ammeter input.

Scale Limits

						Model			
						30kW	60kW	80kW	
405	H.tA1	R/W	Max. scale limit of current transformer CT (phase 1)		0.0 ... 999.9		20.0	40.0	60.0
413	H.tA2		Max. scale limit of current transformer CT (phase 2)		0.0 ... 999.9	With 3-Phase Load	20.0	40.0	60.0
414	H.tA3		Max. scale limit of current transformer CT (phase 3)		0.0 ... 999.9	With 3-Phase Load	20.0	40.0	60.0

Setting the Offset

220	O.tA1	R/W	Offset correction CT input (phase 1)		-99.9 ...99.9 Scale points				0.0
415	O.tA2	R/W	Offset correction CT input (phase 2)		-99.9 ...99.9 Scale points	With 3-Phase Load			0.0
414	O.tA3	R/W	Offset correction CT input (phase 3)		-99.9 ...99.9 Scale points	With 3-Phase Load			0.0

Read State

227 473-139	I.tA1	R	Instantaneous CT input value (phase 1)		Not significant if there is only 1 C (refers to I.1On)				
490	I.tA2	R	Instantaneous CT input value (phase 2)		With 3-PHASE LOAD– Not significant if there is only 1 CT (refers to I.2On)				
491	I.tA3	R	Instantaneous CT input value (phase 3)		th 3-PHASE LOAD– Not significant if there is only 1 CT (refers to I.3On)				
468	I.tA3	R	CT input value with output on (phase 1)						
498	I.2on	R	CT input value with output on (phase 2)						
499	I.3on	R	CT input value with output on (phase 3)						

Advanced Settings

Input Filter

219	Ft.tA	R/W	CT input digital filter (phases 1, 2 and 3)		0.0 ... 20 sec				0.0
Sets a low pass filter on the CT auxiliary input, running the average of values read in the specified time interval. If = 0 , excludes the average filter on sampled values.									

Input Sampling Interval

661	dG.t	R/W	CT input sampling interval		10 ... 999 sec		Only for C4 1TA		10
Sets an interval for the sampling load current value for activation of the SSR_SHORT and NO_CURRENT alarms (see: Power Fault ALARMS).									

Functional Diagram

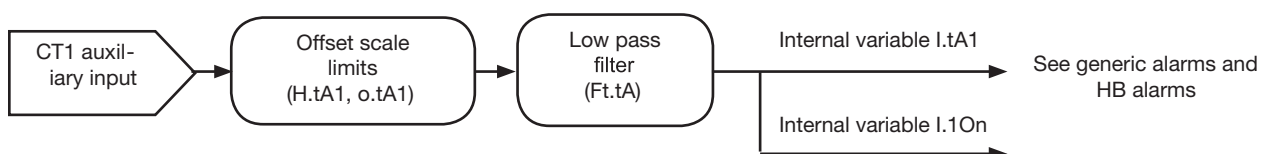

Voltage Value on the Load (Voltmeter)

The voltage read value is present for each zone only on models with 4 CTs (C4-x-x-2-x-x and C4-x-x-4-x-x), and is used to monitor voltage applied to a single-phase or 3-phase load, with automatic recognition of the internal voltmeter transformer.

The value of the voltage applied to the load is saved in variable I.tV1. For each phase, the voltage value is updated while the control output is inactive, otherwise, the value is frozen at the last valid read.

The voltmeter function is significant with:

- 4 independent zones with 4 single-phase loads;
- 1 zone with 3-phase star load with neutral + 1 single-phase zone;
- 1 zone with 3-phase load with open triangle + 1 single-phase zone.

For a zone with single-phase load, the default value of the maximum limit or full scale of the volumetric value (H.tV1) is 530V, and the input is linear on the interval 90...530V. The parameters for correction of offset (o.tV1) and the digital filter (Ft. tV) refer to the voltmeter input.

If zone 1 has a 3-phase load, the following parameters are not significant:

- I.tV1, I.tV2 and I.tV3: voltmeter value on line L1, L2 and L3, respectively;
- I.VF1, I.VF2 and I.VF3: filtered voltmeter value (see Ft.tV) on line L1, L2 and L3;
- H.tV1, H.tV2 and H.tV3: maximum limit or full scale of voltage transformer on line L1, L2 and L3;
- o.tV1, o.tV2 and o.tV3 = offset correction for voltmeter input on line L1, L2 and L3;
- Ft.tV = digital filter for voltmeter input.

NOTE: For load voltage below 90Vac, the voltage read on the load and possible alarms have no value.

Scale Limits

410	HtU1	R/W	Maximum scale limit of voltage transformer TV input (phase 1)	0.0 ... 999.9		530.0
417	HtU2	R/W	Maximum scale limit of voltage transformer TV input (phase 2)	0.0 ... 999.9	with 3-Phase Load	530.0
418	HtU3	R/W	Maximum scale limit of voltage transformer TV input (phase 3)	0.0 ... 999.9	with 3-Phase Load	530.0

Setting the Offset

411	oEtU1	R/W	Offset correction TV input (phase 1)	-99.9 ...99.9 Scale points		0.0
419	oEtU2	R/W	Offset correction TV input (phase 2)	-99.9 ...99.9 Scale points	With 3-Phase Load	0.0
420	oEtU3	R/W	Offset correction TV input (phase 3)	-99.9 ...99.9 Scale points	With 3-Phase Load	0.0

Read State

232 485	I.tU1	R	Value of voltmeter input (phase 1)			
492	I.tU2	R	Value of voltmeter input (phase 2)		With 3-Phase Load	
493	I.tU3	R	Value of voltmeter input (phase 3)		With 3-Phase Load	

Advanced Settings

Input Filter

412	Ft.tU	R/W	Digital filter for auxiliary TV input (phase 1, 2 and 3)	0.0 ... 20 sec		0.0
			Sets a low pass filter on the auxiliary TV input, running the average of values			

Functional Diagram

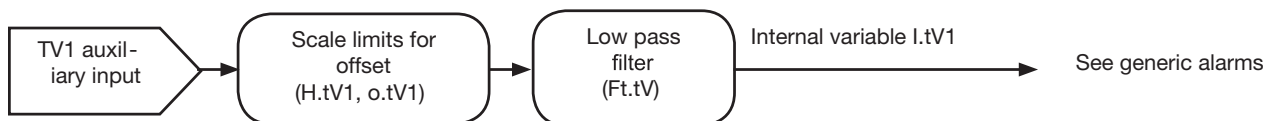

Auxiliary Analog Input (LIN/TC)

The C4 has 4 inputs defined as auxiliary (IN5 for zone 1, IN6 for zone 2, IN7 for zone 3, IN8 for zone 4) to which TC or linear temperature sensors can be connected. The presence of these inputs is optional.

The input value, saved in variable In.2, can be read and used to activate the alarm signals assigned to it.

When an auxiliary input is present, you have to define the following parameters:

- sensor type (AI.2);
- its function (tP.2);
- decimal point position (dP.2);
- scale limits (HS.2 – LS.2);
- offset correction value (oFS.2).

If the sensor is a thermocouple, the minimum and maximum limits can be defined in the specific scale of the sensor used. The range of values settable for alarm setpoints depends on these limits.

There is also a digital filter (Flt.2) that can be used to reduce noise on the input signal.

194	AI.2	R/W	Select type of auxiliary sensor input
-----	------	-----	---------------------------------------

NOTE: Calibrate the UCA inputs by means of the C4-OP terminal. The procedure is described in the C4-OP manual.

Auxiliary Inputs Sensors Table				
Type	Type of Probe or Sensor	Without Dec. Point	With Dec. Point	0
0	TC J °C	0/1000	0.0/999.9	
1	TC J °F	32/1832	32.0/999.9	
2	TC K °C	0/1300	0.0/999.9	
3	TC K °F	32/2372	32.0/999.9	
4	TC R °C	0/1750	0.0/999.9	
5	TC R °F	32/3182	32.0/999.9	
6	TC S °C	0/1750	0.0/999.9	
7	TC S °F	32/3182	32.0/999.9	
8	TC T °C	-200/400	-199.9/400.0	
9	TC T °F	/328/752	-199.9/752.0	
34	0...60 mV	-1999/9999	-199.9/999.9	
35	0...60 mV	Custom Linearization	Custom Linearization	
36	12...60 mV	-1999/9999	-199.9/999.9	
37	12...60mV	Custom Linearization	Custom Linearization	
99	Input Off			

181	tP.2	R/W	Definition of auxiliary analog input function
-----	------	-----	---

Table of Auxiliary Input Functions				
tP.2	Aux. Input Function	Limits for Setting the LS.2 & HS.2		0
		Min.	Mac	
0	None	-1999	9999	
1	Remote Setpoint	Absolute Lo.S, Deviation -999	Absolute Hi.S Deviation +999	(*)
2	Manual Analog Remote	-100.0%	+100.0%	(*)
3	Reset Analog Power	-100.0%	+100.0%	(**)

(*) See Settings: Control Setpoint (**) See Controls: PID Parameters

677	dP.2	R/W	Decimal point position for the auxiliary input scale	Decimal Point Table		0
				dp.2	Format	
				0	xxxx	
				1	xxx.x	
				2	xx.xx(*)	
3	x.xxx(*)					
(*) Not available for TC probes						

Specifies the number of decimal figures used to represent the input signal value: for example, 875.4 (°C) with DPS=1

Scale Probes

404	L5.2	R/W	Minimum limit of auxiliary input scale	Min...max input scale selected in AI.2 e tP.2	0
603	H5.2	R/W	Maximum limit of auxiliary input scale	Min...max input scale selected in AI.2 e tP.2	1000

Setting the Offset

605	oF5.2	R/W	Offset for auxiliary input correction	-999...999 Scale Points	0
-----	-------	-----	---------------------------------------	-------------------------	---

Read State

602	In.2	R	Value of Auxiliary Input	Error Code Table		Description
				0		No error
606	Er.2	R	Error code for self-diagnosis of auxiliary input	1	LO	Value of process variable is < Lo.S
				2	HI	Value of process variable is > Hi.S
				3	ERR	Third wire interrupted for PT100 or input values below minimum limits (ex.: for TC with connection error)
				4	SBR	Probe interrupted or input values beyond maximum health

Advanced Settings

Input Filter

604	FIt.2	R/W	Digital Filter for auxiliary input	0.0...20.0 sec	0.1
-----	-------	-----	------------------------------------	----------------	-----

Sets a low pass filter on the auxiliary input, running the average of values read in the specified time interval. If = 0, excludes the average filter on sampled values

Functional Diagram

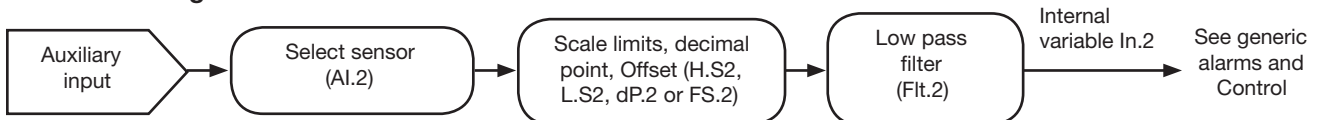

Digital Inputs

There are always two inputs. Each input can perform various functions based on the setting of the following parameters:

140	dIG.1	R/W	Digital Input Function	Digital Input Functions Table		0	Activation
				0	No functions (input off)		
				1	MAN/AUTO controller		On leading edge
				2	LOC / REM		On leading edge
				3	HOLD		On state
				4	AL1, ..., AL4 alarms memory reset		On state
				5	SP1 / SP2 selection		On leading edge
				6	Software on/off		On leading edge
				7	None		
				8	START / STOP Selftuning		On leading edge (**)
				9	START / STOP Autotuning		On leading edge (**)
				10	Power_Fault alarms memory reset		On state
				11	LBA alarm reset		On state
				12	AL1 .. AL4 and Power_Fault alarms reset memory		On state
				13	Enable at software ON (*) + 16 for inverse logic input + 32 to force logic state 0 (OFF) + 48 to force logic state 1 (ON)		

(*) For dIG.1 only

(**) IN dIG.1 alternative to serial

Read State

68	State of Digital Input 1	R	OFF = Digital input 1 off R ON = Digital input 1 on
----	--------------------------	---	--

92	State of Digital Input 2	R	OFF = Digital input 2 off R ON = Digital input 2 on
----	--------------------------	---	--

317		R	State of INPUT DIG digital inputs	bit.0 = state dIG bit.1 = state dIG.2
-----	--	---	-----------------------------------	--

Functions Related to Digital Inputs

- MAN / AUTO controller see AUTO/MAN CONTROL
- LOC / REM..... see SETTING THE SETPOINT
- HOLD see HOLD FUNCTION
- Reset memory latch..... see GENERIC ALARMS AL1 .. AL4
- Select SP1 / SP2 see SETTINGS - Multiset
- Software OFF / ON see SOFTWARE SHUTDOWN
- START / STOP Selftuning see SELFTUNING
- START / STOP Autotuning..... see AUTOTUNING



Do not use the Digital Input function within this device as an E-Stop or in a power OFF safety circuit.



When item is activated by “leading edge” care should be taken that the parameter maybe changed via communications, regardless of the status of the digital input state.

Using a Function Associated with Digital Input and Via Serial

At power-on or on the leading edge of digital input 1 or 2, all zones assume the state set by the digital input. For each zone, this state can be changed by writing via serial.

The setting via serial is saved in eeprom (STATUS_W_EEP, address 698).

State AB	Setting dIG.1 or dIG.2	Address for Writing via Serial	
		Access at 16 Bits	Access at 1Bit
AUTO/MAN controller	1 word 305	bit 4	bit 1
LOC/REM setpoint	2 word 305	bit 6	bit 10
SP1/SP2 setpoint	5 word 305	bit 1	bit 75
ON/OFF software	6 word 305	bit 3	bit 11
STOP/START selftuning	8 word 305	bit 2	bit 3
STOP/START autotuning *	9 word 305	bit 5	bit 29

* continuous or one-shot.

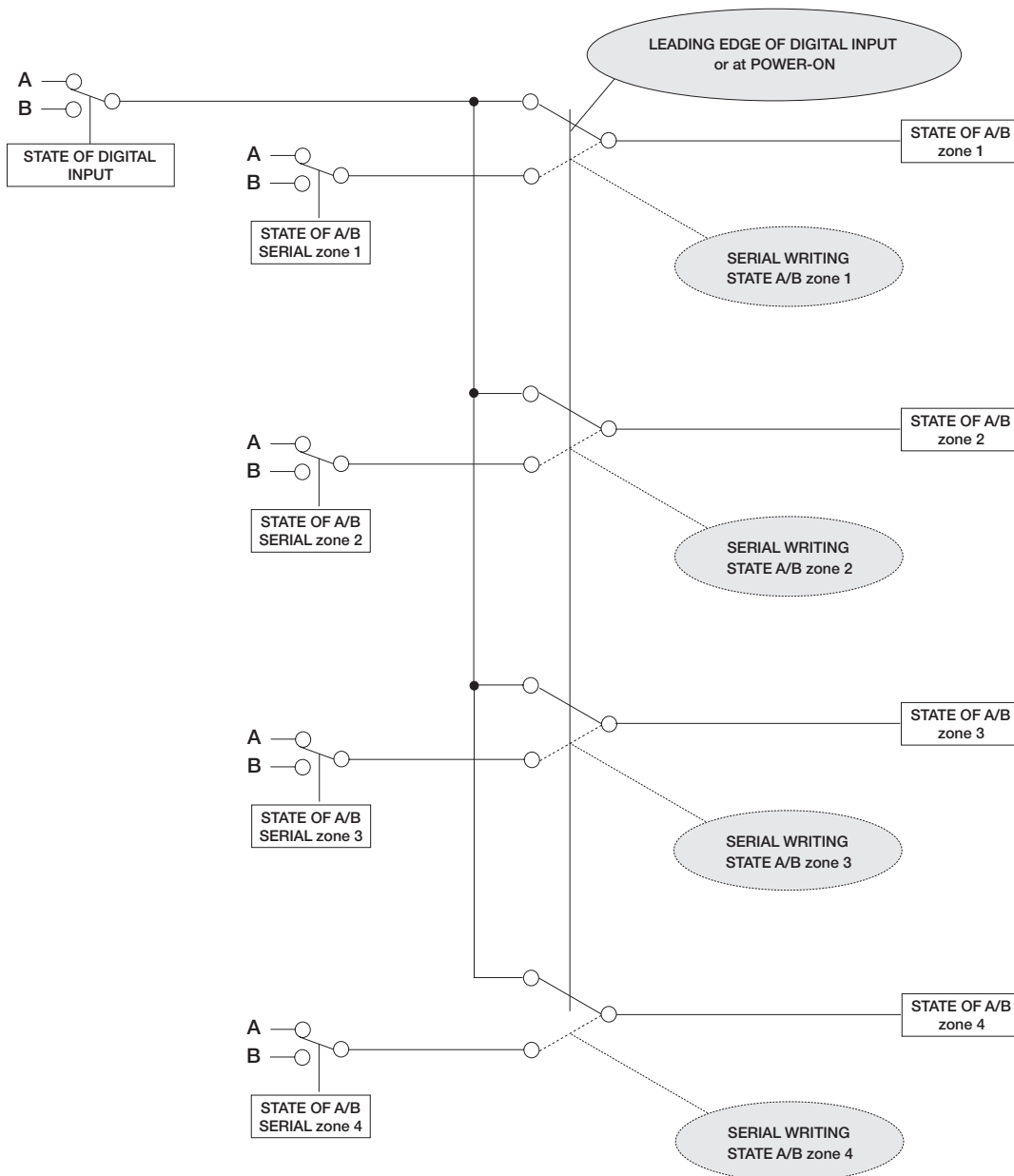

Using a Function of Digital Input 1 to Enable at Software On

Software ON can be configured either by enabling a digital input or by writing via serial. Enabling by digital input 1 (diG) is common to all zones, whereas enabling via serial is specific for each individual zone.

The ON/OFF setting via serial is saved in eeprom (STATUS_W_EEP, address 698 bit 3) for resetting of the condition at the next hardware power-on; use parameter P.On.t. to force software always ON or software always OFF at next power-on.

State AB	Setting diG	Address for Writing via Serial	
		Access at 16 Bits	Access at 1Bit
ON/OFF Software	13	Word 305 bit 3	Bit 11

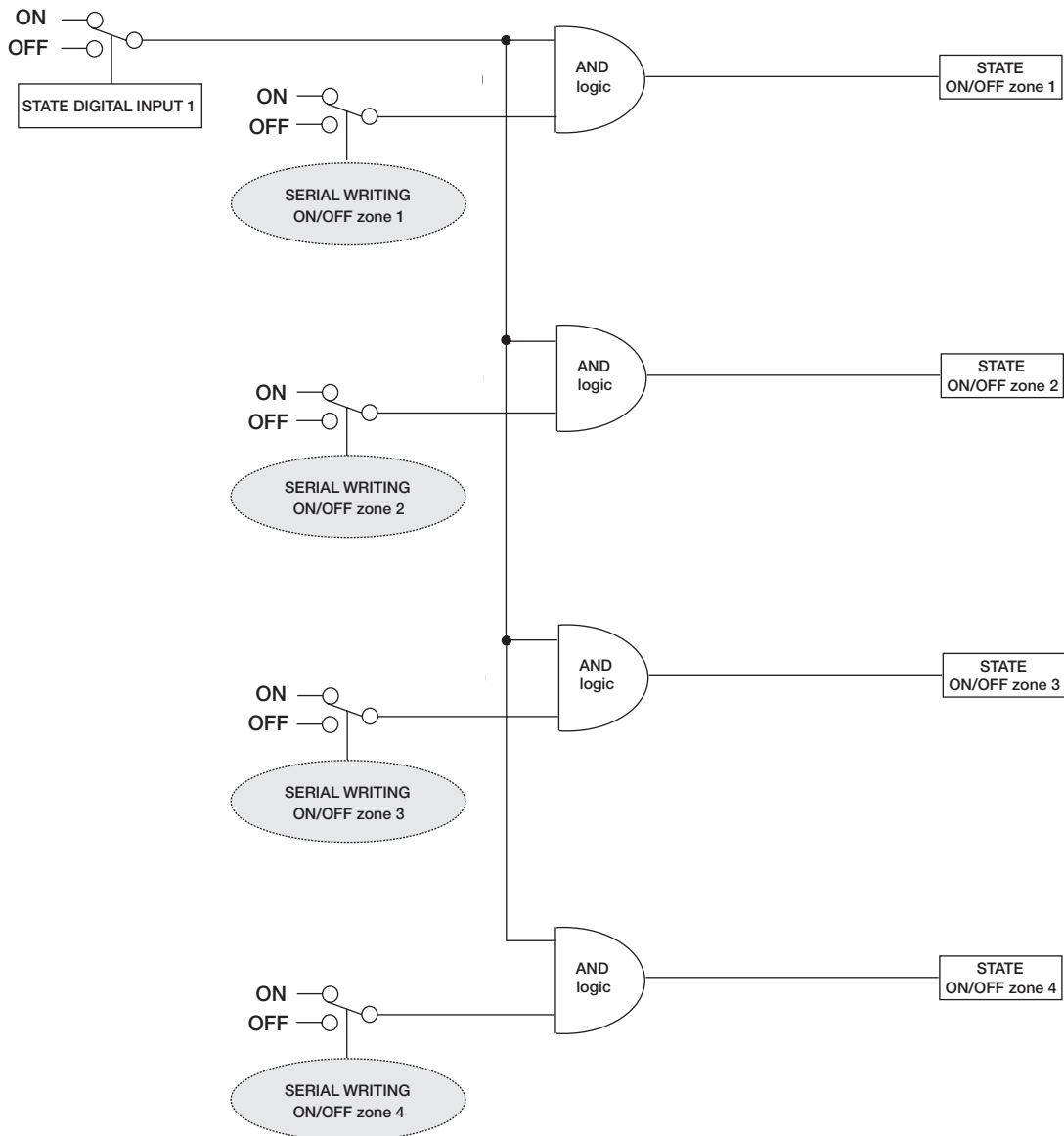

Alarms

Generic Alarms AL1, AL2, AL3, and AL4

Generic Alarms AL1, AL2, AL3, and AL4

Four generic alarms are always available and can perform various functions. Typically, alarm AL.1 is defined as minimum and AL.2 as maximum.

These alarms are set as follows:

- select the reference variable to be used to monitor the value (parameters A1.r, A2.r, A3.r and A4.r): the origin of the variable can be chosen from the process variable PV (generally linked to the main input), the ammeter input, the voltmeter input, the auxiliary analog input, or the ac-tive setpoint.
- set the value of the alarm setpoint (parameters AL.1, AL.2, AL.3 and AL.4).

This value is used for comparison with the reference variable value: it can be absolute or indicate a shift from the variable in case of deviation alarm.

- set the hysteresis value for the alarm (parameters Hy.1, Hy.2, Hy.3 and Hy.4): the hysteresis value defines a band for safe re-entry of the alarm condition: without this band, the alarm would be deactivated as soon as the reference variable re-entered the setpoint limits, with the possibility of generating another alarm signal in the presence of oscillations of the reference signal around the setpoint value.
- select alarm type:
 - absolute/deviation: if the alarm refers to an absolute value or to another variable (for example, to the setpoint).
 - direct/reverse: if the reference variable exceeds the alarm setpoint in the “same direction” as the control action or not. For example, the alarm is direct if the reference variable exceed the upper setpoint value during heating or assumes values below:

Normal absolute alarm

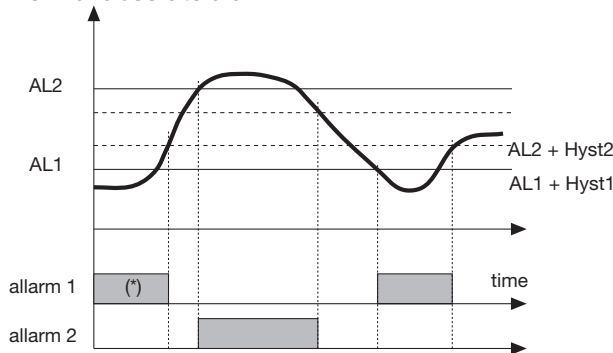

For AL1 reverse absolute alarm (low) with positive Hyst1, AL1 t = 1 (*) = OFF if disabled at switch on
 For AL2 direct absolute alarm (high) with negative Hyst2, AL2 t = 0

Symmetrical absolute alarm

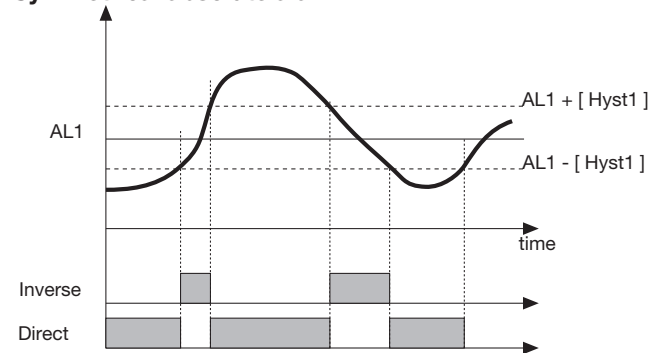

For AL1 = symmetrical inverse absolute alarm with Hyst1, AL1 t = 5
 For AL1 = symmetrical direct absolute alarm with Hyst1, AL1 t = 4
 Minimum hysteresis = 2 scale points

Deviation alarm

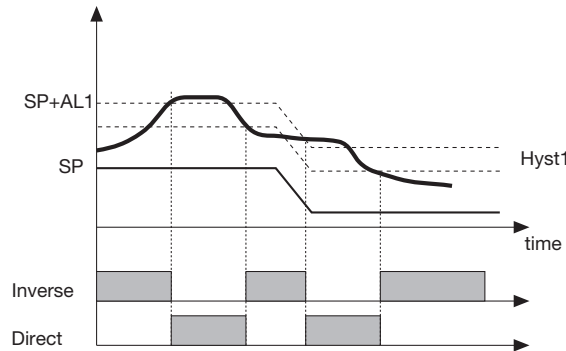

For AL1 = normal inverse deviation alarm with negative Hyst 1, AL1 t = 3
 For AL1 = normal direct deviation alarm with negative Hyst 1, AL1 t = 2

Symmetrical deviation alarm

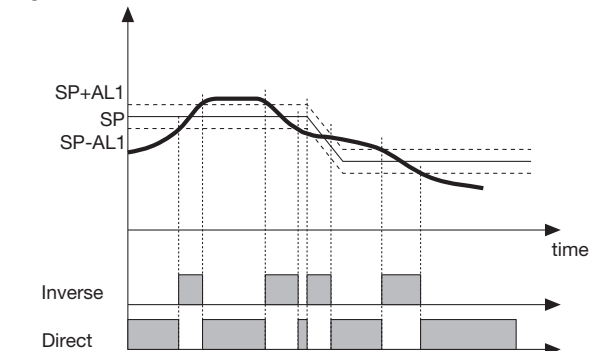

For AL1 = Symmetrical inverse deviation alarm with Hyst 1, AL1 t = 7
 For AL1 = Symmetrical direct deviation alarm with Hyst 1, AL1 t = 6

Reference Variables

Code	Variable	Access	Description	Table of Alarm Reference Setpoints			
				Type	Variable to be Compared	Reference Setpoint	
215	R1r	R/W	Select Reference Variable Alarm 1	0	PV (process variable)	AL	0
216	R2r	R/W	Select Reference Variable Alarm 2	1	in.tA1 AL (In.tA1 OR In.tA2 OR In.tA3 WITH 3-PHASE LOAD)	AL	0
217	R3r	R/W	Select Reference Variable Alarm 3	2	In.tV1 AL (In.tV1 OR In.tV2 OR In.tV3 WITH 3-PHASE LOAD)	AL	0
218	R4r	R/W	Select Reference Variable Alarm 4	3	SPA (active setpoint)	AL (absolute only)	0
				4	PV (process variable)	AL [deviation only and referred to SP1 (with multiset function)]	
				5	In.2 auxiliary input	AL	

N.B. for codes 1, 2 and 5, the reference to the alarm is in scale points and not to the decimal point (d.P)

Alarm Setpoints

12 457-177	AL1	R/W	Alarm setpoint 1 (scale points)	500
13 476-178	AL2	R/W	Alarm setpoint 2 (scale points)	100
14 52-479	AL3	R/W	Alarm setpoint 3 (scale points)	700
58 480	AL4	R/W	Alarm setpoint 4 (scale points)	800

Alarm Hysteresis

27 187	HY1	R/W	Hysterisis for Alarm 1	999 Scale points	0...999 sec. Se +32 in A1.t 0...999 min. Se +64 in A1.t	-1
30 188	HY2	R/W	Hysterisis for Alarm 2	999 Scale points	0...999 sec. Se +32 in A1.t 0...999 min. Se +64 in A1.t	-1
53 189	HY3	R/W	Hysterisis for Alarm 3	999 Scale points	0...999 sec. Se +32 in A1.t 0...999 min. Se +64 in A1.t	-1
59	HY4	R/W	Hysterisis for Alarm 4	999 Scale points	0...999 sec. Se +32 in A1.t 0...999 min. Se +64 in A1.t	-1

Alarm Type

406	A1.t	R/W	Alarm Type 1	Table of Alarm behaviour				
407	A2.t	R/W	Alarm Type 2	AL.x.t	Direct (High Limit) Inverse (Low Limit)	Absolute Relative to Active Setpoint	Normal Symmetrical (Window)	0
408 (54)	A3.t	R/W	Alarm Type 3	0	direct	absolute	normal	
				1	inverse	absolute	normal	0
				2	direct	relative	normal	0
				3	inverse	relative	normal	0
				4	direct	absolute	symmetrical	0
				5	inverse	absolute	symmetrical	0
				6	direct	relative	symmetrical	0
				7	inverse	relative	symmetrical	
<ul style="list-style-type: none"> • 8 to disable at switch-on until first setpoint + 16 to enable memory latch • 32 Hys becomes delay time for activation of alarm (0...999 sec.) (excluding absolute symmetrical) • 64 Hys becomes delay time for activation of alarm (0...999 min.) (excluding absolute symmetrical) • 136 to disable at switch-on or at change of setpoint until first setpoint • 256 only for alarms with memory and delay time: the delay time becomes a timed hysteresis (with time stopped in case of SBR condition: when SBR condition disappears the delay time starts counting from zero) 								

46 bit	AL1 Direct/Inverse	R/W
47 bit	AL1 Absolute/Relative	R/W
48 bit	AL1 Normal/Symmetrical	R/W
49 bit	AL1 Disabled at Switch-On	R/W
50 bit	AL1 with Memory	R/W
54 bit	AL2 Direct/Inverse	R/W
55 bit	AL2 Absolute/Relative	R/W
56 bit	AL2 Normal/Symmetrical	R/W
57 bit	AL2 Disabled at Switch-On	R/W
58 bit	AL2 With Memory	R/W
36 bit	AL3 Direct/Inverse	R/W
37 bit	AL3 Absolute/Relative	R/W
38 bit	AL3 Normal/Symmetrical	R/W
39 bit	AL3 Disabled at Switch-On	R/W
40 bit	AL3 With Memory	R/W
70 bit	AL4 Direct/Inverse	R/W

Limits of Absolute Alarm Settings

25 20-28-142	Lo.L	R/W	Lower settable limit SP, SP remote and absolute alarms	Lo.S...Hi.S	See: SETTINGS—Setpoint Control	0
26 21-29-143	Hi.L	R/W	Upper settable limit SP, SP remote and absolute alarms	Lo.S...Hi.S		1000

Enable Alarms

195	AL.n	R/W	Select Number of Enabled Alarms	Table of Enabled Alarms					0
				AL.nr	Alarm 1	Alarm 2	Alarm 3	Alarm 4	
				0	disabled	disabled	disabled	disabled	
				1	enabled	disabled	disabled	disabled	
				2	disabled	enabled	disabled	disabled	
				3	enabled	enabled	disabled	disabled	
				4	disabled	disabled	enabled	disabled	
				5	enabled	disabled	enabled	disabled	
				6	disabled	enabled	enabled	disabled	
				7	enabled	enabled	enabled	disabled	
				8	disabled	disabled	disabled	enabled	
				9	enabled	disabled	disabled	enabled	
				10	disabled	enabled	disabled	enabled	
				11	enabled	enabled	disabled	enabled	
				12	disabled	disabled	enabled	enabled	
				13	enabled	disabled	enabled	enabled	
				14	disabled	enabled	enabled	enabled	
				15	enabled	enabled	enabled	enabled	

+ 16 to enable HB alarm
+ 32 to enable LBA alarm

Reset Memory Latch

140	DI.1	R/W	Digital Input Function	Digital Input Functions Table			0
618	DI.2	R/W	Digital Input Function 2				0
				0	No function (input off)		
				1	MAN /AUTO controller		
				2	LOC / REM		
				3	HOLD		
				4	AL1, ..., AL4 latch alarm reset		
				5	SP1 / SP2 selection		
				6	Software on/off		
				7	None		
				8	START / STOP Selftuning		
				9	START / STOP Autotuning		
				10	Power_Fault latch alarm reset		
				11	LBA alarm reset		
				12	AL1 .. AL4 and Power_Fault latch alarm reset		
				13	Enable at software ON (*)		
					+ 16 for inverse logic input		
					+ 32 to force logic state 0 (OFF)		
					+ 48 to force logic state 1 (ON)		

79 bit	Reset Memory Latch	R/W	
--------	--------------------	-----	--

Read State

4 bit	State of Alarm 1	R	OFF = Alarm off ON = Alarm on
5 bit	State of Alarm 2	R	OFF = Alarm off ON = Alarm on
62 bit	State of Alarm 3	R	OFF = Alarm off ON = Alarm on
69 bit	State of Alarm 4	R	OFF = Alarm off ON = Alarm on

318		R	State of Alarms ALSTATE IRQ	0 ...255	States of Alarms Table	
				bit		
				0	State AL.1	
				1	State AL.2	
				2	State AL.3	
				3	State AL.4	
				4	State AL.HB (if 3-phase or phase 1/2/3) or Power Fault	
				5	State AL.HB PHASE 1 (if 3-phase)	
				6	State AL.HB FASE 2 (if 3-phase)	
				7	State AL.HB FASE 3 (if 3-phase)	

Functional Diagram

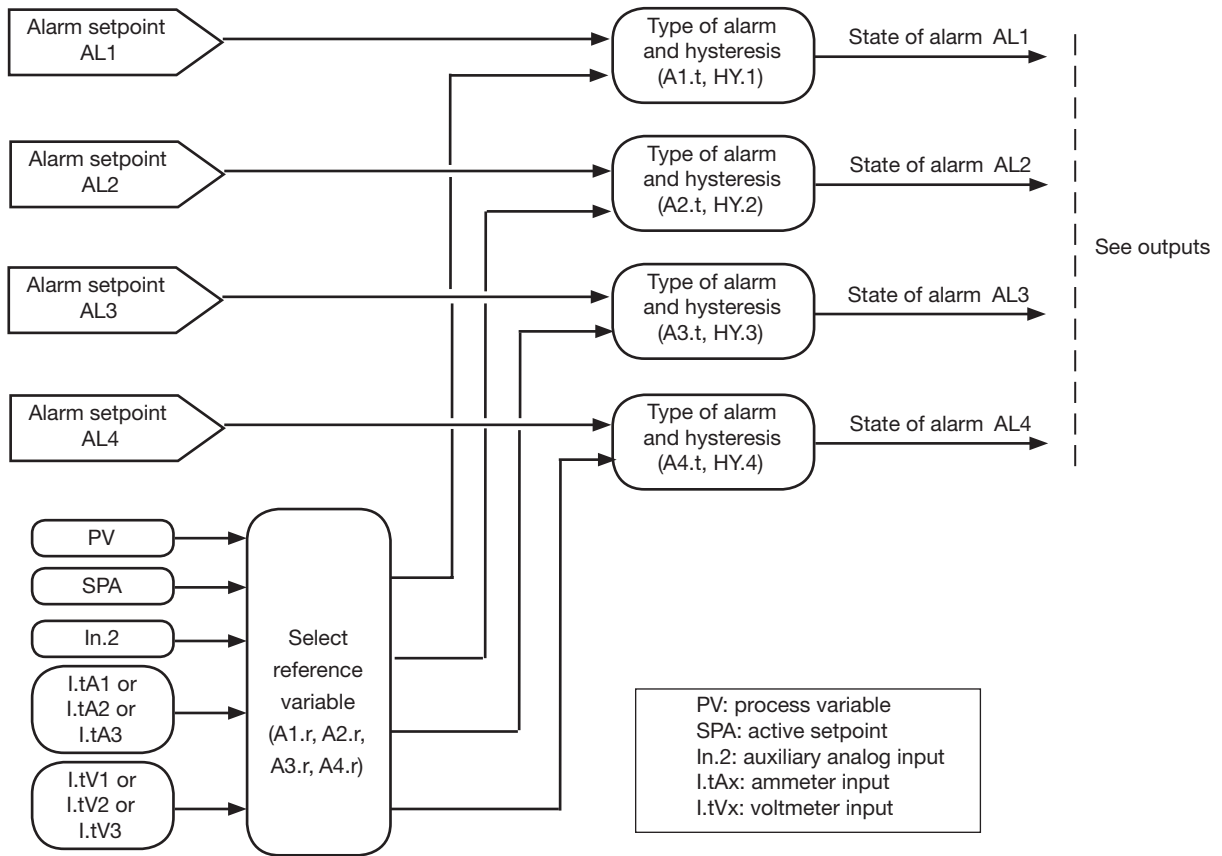

LBA Alarm (Loop Break Alarm)

LBA is an alarm type that monitors the overall control loop status of the Process Value, the status of the outputs, and compares them for monitoring the system.

LBA alarm will identify incorrect functioning of the control loop due to a possible short relay, open relay, heater element failure, shorted probe, or incorrectly positioned probe, or reversed probe.

It is best suited for startups of equipment from cold where situation when possible components have failed or may have been moved. LBA can be used in heating or cooling applications.

Do not use LBA as a replacement for safety or over temperature protection.

With the alarm enabled (parameter AL.n), the instrument checks that in condition of maximum power delivered for a settable time (Lb.t) greater than zero, the value of the process variable increases in heating or decreases in cooling: if this does not happen, the LBA alarm trips. In these conditions, power is limited to value (Lb.P).

The alarm condition resets if the temperature increases in heating or decreases in cooling.

Enable Alarm

195	AL.n	R/W	Select number of enabled alarms		See Table of Enabled Alarms	0
44	Lb.t	R/W	Delay time for tripping LBA Alarm	0.0 ... 500.0 min	If Lb.t = 0, the LBA alarm is disabled	30.0
119	Lb.P	R/W	Limitation of power delivered in presence of LBA alarm	-100.0 ..100.0%		25.0
81 bit	Reset LBA Alarm	R/W				

Read State

8 bit	State of LBA Alarm	R	OFF = LBA Alarm off ON = LBA Alarm on
-------	--------------------	---	--

Functional Diagram

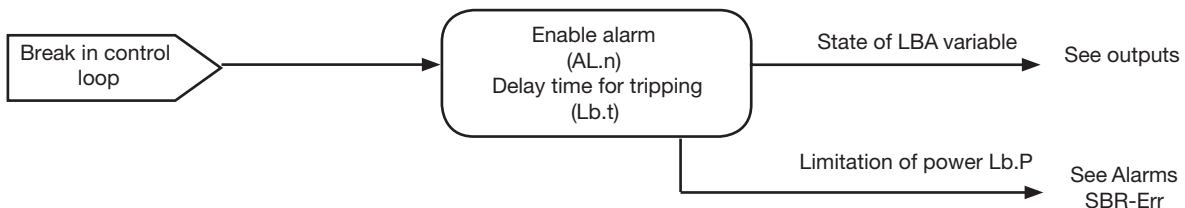

HB Alarm (Heater Break Alarm)

This alarm monitors and identifies the actual current that is on the heater load by means of a current transformer (CT). In the C4, it can be either one or four CT's. In the C4X, it is external mounted CT's.

HB Alarm is monitoring on three fault situations. Actual current level is lower than the alarm setting. This usually indicates that a partial failure or complete failure of the heating element.

Actual current level is higher than rated or expected load. This may indicate partial short circuits of the heating element.

Current is present at the heating element when the output to the heating element is off. An possible indication of shorted relay contacts, or short power to the heating element.

In a standard configuration, output OUT1 is associated to heating control in zone 1, obtained by modulating electrical power with the ON/OFF control based on the set cycle time.

A current reading is performed during the ON phase identifies an anomalous shift from the rated value due to a load break (first two fault situations described above), while the current read performed during the OFF phase identifies a break in the control re-ly, with consequent output always active (third fault situation).

The alarm is enabled by means of parameter AL.n; select the type of function you want by means of parameter Hb.F:

Hb.F=0: alarm activates if the current load value is below the setpoint value set in A.Hbx while the associated control out-put is ON.

Hb.F=1: alarm activates if the current load value is above the setpoint value set in A.Hbx while the associated control out-put is OFF.

Hb.F=2: alarm activates by combining functions 0 and 1, considering the setpoint of function 1 as 12% of the ammeter full scale defined in H.tAx.

Hb.F=3 or Hb.F=7 (continuous alarm): alarm activates due to a load current value below the setpoint value set in A.Hbx; this alarm does not refer to the cycle time and is disabled if the heating (cooling) output value is below 3%.

Setting A.Hbx = 0 disables both types of HB alarm by forcing deactivation of the alarm state.

The alarm resets automatically if its cause is eliminated.

An additional configuration parameter for each zone, related to the HB alarm is:

Hb.t = delay time for activation of HB alarm, understood as the sum of times for which the alarm is considered active.

For example, with:

- Hb.F = 0 (alarm active with current below setpoint value),

- Hb.t = 60 sec and cycle time of control output = 10 sec,

- power delivered at 60%, the alarm will activate after 100 sec (output ON for 6 sec each cycle);

if power is delivered at 100%, the alarm will activate after 60 sec.

If the alarm deactivates during this interval, the time sum is reset.

The delay time set in Hb.t must exceed the cycle time of the associated output.

If zone 1 has a 3-phase load, you can set three different setpoints for the HB alarm:

A.Hb1= alarm setpoint for line L1

A.Hb2= alarm setpoint for line L2

A.Hb3= alarm setpoint for line L3

Enable Alarm

195	AL.n	R/W	Select number of enabled alarms	See Table of Enabled Alarms	0
57	Hb.F	R/W	HB Alarm Functions	Table of HB Alarm Functions	0
			Default:		
			<u>SINGLE-PHASE LOAD</u> : each A.HbX refers to its respective phase.		
			<u>2-PHASE LOAD</u> : single reference setpoint A.Hb1 and OR between phases 1, 2 and phases 3, 4.		
			<u>3-PHASE LOAD</u> : single reference setpoint A.Hb1 and OR among phases 1, 2 and 3.		
			+ 8 HB reverse alarm		
			+ 16 relates to single setpoints and singled phases WITH 3-PHASE LOAD		
56	Hb.t	R/W	Delay time for activation of HB Alarm	0 ... 999 sec	The value must exceed the cycle time of the 0 ... 999 sec output to which the HB alarm is associated. 25.0

Val.	Description of functions
0	Relay, logic output: alarm active at a load current value below set point for control output ON time.
1	Relay, logic output: alarm active at a load current value above set point for control output OFF time.
2	Alarm active if one of functions 0 and 1 is active (OR logic between functions 0 and 1) (*)
3	Continuous heating alarm
7	Continuous cooling alarm
(*) minimum setpoint is set at 12% of ammeter full scale	

Alarm Setpoints

55	R_Hb1	R/W	HB alarm setpoint (scale points ammeter input - Phase 1)		10.0
502	R_Hb2	R/W	HB alarm setpoint (scale points ammeter input - Phase 2)	With 3-phase load	10.0
503	R_Hb3	R/W	HB alarm setpoint (scale points ammeter input - Phase 3)	With 3-phase load	10.0

Read State

26 Bit	HB ALARM STATE OR POWER_FAULT	R	OFF = Alarm off ON = Alarm on		
76 Bit	State of HB alarm phase 1TA	R			
77 Bit	State of HB alarm phase 3TA	R			
78 Bit	State of HB alarm phase 3TA	R			
504		R	HB alarm states ALSTATE_HB (for 3-phase loads)	0 ... 255	Table of HB Alarm States
				Bit	
				0	HB TA2 time ON
				1	HB TA2 time OFF
				2	HB alarm TA2
				3	HB TA3 time ON
				4	HB TA3 time OFF
				5	HB alarm TA3
512		R	States of alarm ALSTATE (for single-phase loads)	0 ... 255	Table of alarm states ALSTATE
				Bit	
				4	HB alarm time ON
				5	HB alarm time OFF
				6	HB alarm

Read State

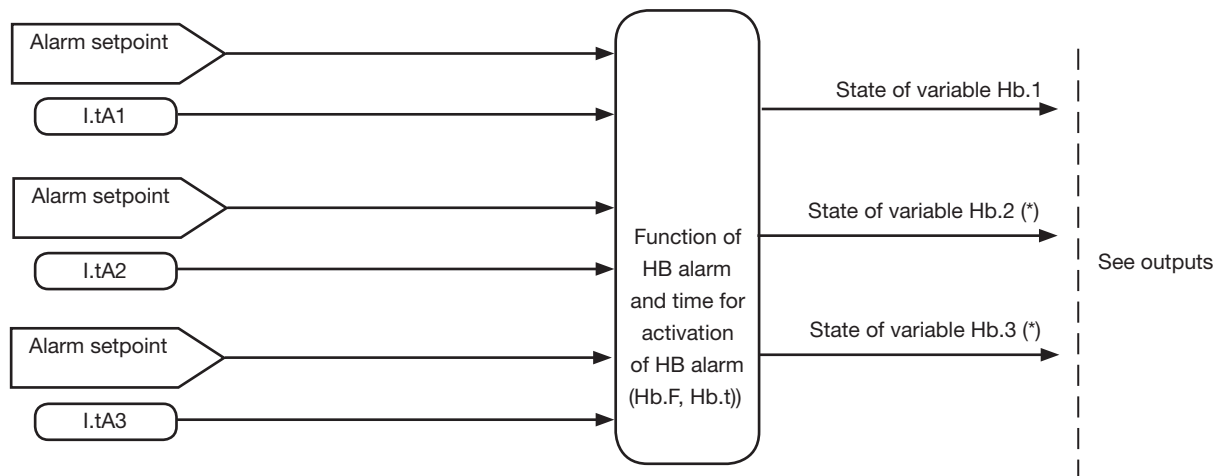

(*) - Only for 3-phase applications
I.tAx: ammeter input

Alarm SBR—ERR (Probe in short or connection error)

This alarm is always ON and cannot be deactivated. It controls correct functioning of the probe connected to the main input.

In case of broken probe:

- the state of alarms AL1, AL2, AL3, and AL4 is set based on the value of parameter rEL;

- control power control is set to the value of parameter FAP.

Identification of the type of break detected on the main input is contained in Err.

Enable Alarm

229	rEL	R/W	Fault action (definition of state in case of broken probe) Sbr, Err Only for main input	Table of Probed Alarm Settings					0
				_rEL	Alarm 1	Alarm 2	Alarm 3	Alarm 4	
0	OFF	OFF	OFF	OFF					
1	ON	OFF	OFF	OFF					
2	OFF	ON	OFF	OFF					
3	ON	ON	OFF	OFF					
4	OFF	OFF	ON	OFF					
5	ON	OFF	ON	OFF					
6	OFF	ON	ON	OFF					
7	ON	ON	ON	OFF					
8	OFF	OFF	OFF	ON					
9	ON	OFF	OFF	ON					
10	OFF	ON	OFF	ON					
11	ON	ON	OFF	ON					
12	OFF	OFF	ON	ON					
13	ON	OFF	ON	ON					
14	OFF	ON	ON	ON					
15	ON	ON	ON	ON					

228	FAP	R/W	Fault Action Power (supplied in conditions of broken probe)	-100.0 ..100.0 %	see: SPECIALIZED CONTROL FUNCTIONS	30.0
-----	-----	-----	---	------------------	------------------------------------	------

Read State

85	Err	R	Error code in self-diagnostics of main input	See: Table of error codes
----	-----	---	--	---------------------------

9 Bit	STATE OF INPUT IN SBR	R	OFF = - ON = Input in SBR
-------	-----------------------	---	------------------------------

Functional Diagram

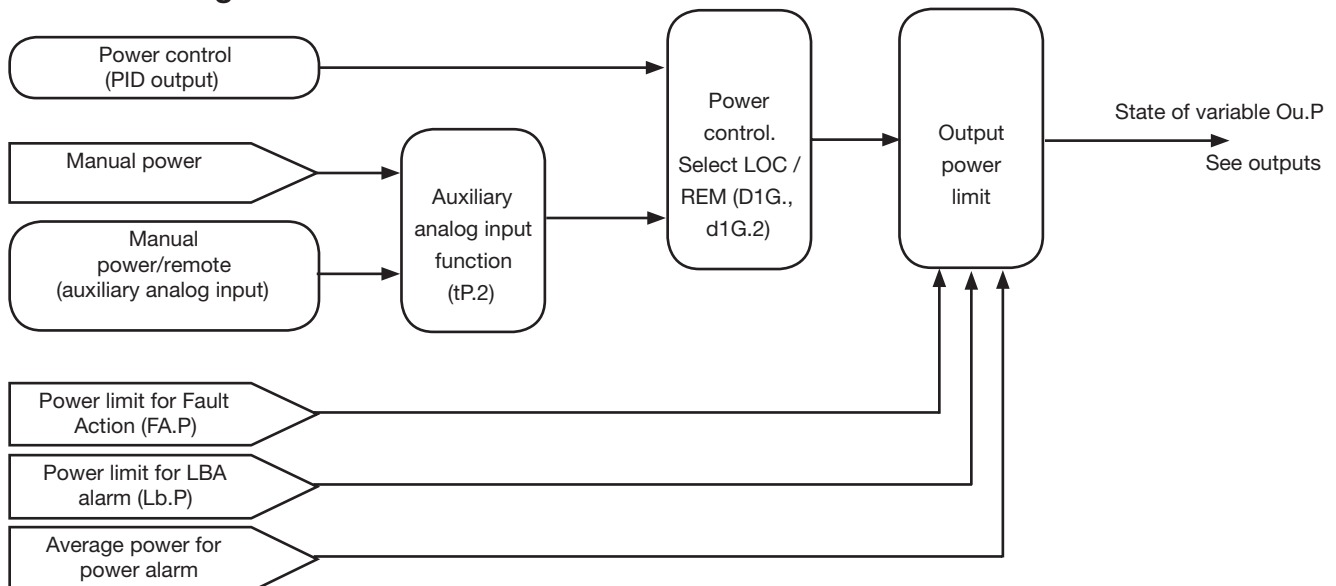

**Power Fault Alarms (SSR Short, No_Voltage, SSR_Open and No_Current)
C4 With 4 Current Transformers**

660	hd.2	R/W	Enable POWER_FAULT alarms	Table of Power Fault Alarms					0
				Hd.2	SSR Short	NO_VOLTAGE	SSR Open	NO_CURRENT	
				0					
				1	X				
				2		X			
				3	X	X			
				4			X		
				5	X		X		
				6		X	X		
				7	X	X	X		
				8				X	
				9	X			X	
				10		X		X	
				11	X	X		X	
				12			X	X	
				13	X		X	X	
14		X	X	X					
15	X	X	X	X					

32 Alarms with memory
NOTE: The NO_CURRENT alarm setpoint is fixed at 1A

661	dG.t	R/W	Refresh rate SSR Short The alarm activates after 3 faults.	1...999 sec	0
662	dG.F	R/W	Time filter for NO_VOLTAGE, SSR_OPEN and NO_CURRENT alarms. Note: set a value not inferior to cycle time.	1...999 sec	0

Note: With output power at 100%, NO_VOLTAGE alarm in diagnostic is detected only if an SSR SHORT code is active.

Note related to the parameter dG.t only with 4CT
*For dG.t < 10 sec, the SSR SHORT alarm is detected every dG.t seconds only when power = 0%
*For dG.t > 10 sec, the SSR SHORT alarm is detected every dG.t seconds switching off the power for 60 msec, independently from the power value.

C4 With 1 Current Transformers

660	hd.2	R/W	Enable POWER_FAULT alarms	Table of Power Fault Alarms					0
				Hd.2	SSR Short	NO_VOLTAGE	SSR Open	NO_CURRENT	
				0					
				1	X				
				2					
				3	X				
				4					
				5	X				
				6					
				7	X				
				8				X	
				9	X			X	
				10				X	
				11	X			X	
				12				X	
				13	X			X	
14				X					
15	X			X					

32 Alarms with memory.
NOTE: Activation and state of alarm SSR SHORT is global for all 4 zones. The NO_CURRENT alarm setpoint is fixed at 1A

661	dG.t	R/W	Refresh rate in CT, SSR SHORT, and NO_CURRENT alarms The alarm activates after 3 faults	1...999 sec	0
662	dG.P	R/W	Minimum power for acquisition in CT and for NO_CURRENT alarm	0.0...100.0%	10

Note: With output power <dG.P the SSR SHORT alarm in diagnostic is not detected

C4X With 4 Current Transformers

660	hd. 2	R/W	Enable POWER_FAULT alarms	Table of Power Fault Alarms					0
				Hd.2	SSR Short	NO_VOLTAGE	SSR Open	NO_CURRENT	
				0					
				1	X				
				2					
				3	X				
				4					
				5	X				
				6					
				7	X				
				8				X	
				9	X			X	
				10				X	
				11	X			X	
				12				X	
				13	X			X	
14				X					
15	X			X					

32 Alarms with memory
NOTE: The NO_CURRENT alarm setpoint is fixed at 1A

661	dc. t	R/W	Refresh rate SSR Short The alarm activates after 3 faults.	1...999 sec	0
662	dc. f	R/W	Time filter for NO_CURRENT alarms NOTE: set a value not inferior to cycle time.	1...999 sec	0

Read State

105 bit	Reset SSR_OPEN / SSR_SHORT / NO_VOLTAGE / NO_CURRENT alarms	R/W
93 bit	State of alarms SSR_OPEN phase 1	R
94 Bit	State of alarms SSR_OPEN phase 2	R
95 Bit	State of alarms SSR_OPEN phase 3	R
96 Bit	State of alarms SSR_SHORT phase 1	R
97 Bit	State of alarms SSR_SHORT phase 2	R
98 Bit	State of alarms SSR_SHORT phase 3	R
99 Bit	State of alarms NO_VOLTAGE phase 1	R
100 Bit	State of alarms NO_VOLTAGE phase 2	R
101 Bit	State of alarms NO_VOLTAGE phase 3	R
102 Bit	State of alarms NO_CURRENT phase 1	R
103 Bit	State of alarms NO_CURRENT phase 2	R
104 bit	State of alarms NO_CURRENT phase 3	R

Overheat Alarm

The C4 and C4-IR has an internal heat sink that is temperature monitored and can disable the outputs when an overheat condition is met. The overheat alarm is not programmable but is a read only parameter within communications parameters. The Overheat Alarm is for the protection of the power control hardware in the C4.

There are two type of methods that the overheat temperature is monitored. In each case the outputs 1, 2, 3, 4 will be disabled.

- * Temperature exceeds 85°C.
The C4 will reset this alarm once the heat sink temperature falls below 75°C.
- * Temperature rise of 7°C in 12 seconds.

655		R	INPTC: SSR Temperature	°C
675		R	INPTC_DER: Derivative of the SSR temperature	°C/12 sec

NOTE! The usual reason for an overheat condition is blocked air vents or by a blocked cooling fan.

Outputs

The modular power controller has high flexibility in the assignment of functions to the physical outputs. As a result, the instrument can be used in sophisticated applications.

A function is assigned to each physical output in two steps: first assign the function to one of internal reference signals rL.1 .. rL.6, and then attribute the reference signal to parameters out.1 .. out.10 (corresponding to physical outputs OUT1 .. OUT10).

In standard configuration, physical outputs Out1, Out2, Out3, Out4 perform the heating control function (Heat) for zone 1, zone 2, zone 3 and zone 4, respectively; value 0 (function HEAT) is assigned to reference signals rL.1 in each zone, and the following values to the output parameters: out.1=1 (output rL.1 zone 1), out.2=2 (output rL.1 zone 2), out.3=3 (output rL.1 zone 3) and out.4=4 (output rL.1 zone 4).

Physical outputs Out5, Out6, Out7, Out8 are optional, and the type (relay, logic, continuous or triac) is defined by the order code. In standard configuration, these outputs perform the cooling control function (Cool) for zone 1, zone 2, zone 3 and zone 4, respectively. In this configuration, value 1 (function COOL) is assigned to reference signals rL.2 in each zone, and the following values to the output parameters: out.5=5 (output rL.2 zone 1), out.6=6 (output rL.2 zone 2), out.7=7 (output rL.2 zone 3) and out.8=8 (output rL.2 zone 4).

Relay outputs Out9 and Out10 are always present, programmable by means of parameters out.9 and out.10, to which available alarm signal functions are assigned by means of the four reference signals rL.3, rL.4, rL.5, rL.6 in each zone.

Standard configuration has the following assignments:

- reference signals: rL.3=2 (function AL1), rL.4=3 (function AL2), rL.5=4 (function AL3) and rL.6=5 (function AL.HB or POWER_FAULT with HB alarm).
- output parameters: out.9 =17 and out.10 =18.

In this way, the state of output physical Out9 is given by the logic OR of AL1, AL3 in each zone, and the state of output Out10 is given by the logic AND of AL2, AL.HB in each zone.

Each output can always be disabled by setting parameter out.x = 0.

The state of outputs Out1,...,Out10 can be acquired by serial communication by means of bit variables.

The following additional configuration parameters are related to the outputs:

Ct.1 = cycle time for output rL.1 for heating control (Heat). See SETTINGS

Ct.2 = cycle time for output rL.2 for cooling control (Cool). See SETTINGS

rEL = alarm states AL1, AL2, AL3, AL4 in case of broken probe, Err, Sbr. See Generic Alarms

Allocation of Reference Signals

160	rL.1	R/W	Allocation of reference signal
-----	------	-----	--------------------------------

163	rL.2	R/W	Allocation of reference signal
-----	------	-----	--------------------------------

NOTE: Parameters rL.1, ..., rL.6 for each zone can be considered as internal states.

Ex.: To assign alarm AL1 to physical output OUT5, assign rL.1-Zone1=2 (AL1-alarm 1) and then assign parameter out.5=1 (rL.1-Zone1)

+ 32 for logic level denied in output
+ 128 to force output to zero

NOTE: continuous COOL OUTPUTS can be assigned codes 0, 1, 64 and 65 only, with cycle time fixed at 100 ms

Table of Reference Signals		0
Value	Function	1
0	HEAT (heating control output) / in case of continuous output 0...20mA / 0...10V	
1	COOL (cooling control output) / in case of continuous output 0...20mA / 0...10V	
2	AL1 - alarm 1	
3	AL2 - alarm 2	
4	AL3 - alarm 3	
5	AL.HB or POWER_FAULT with HB alarm (TA1 OR TA2 OR TA3)	
6	LBA - LBA alarm	
7	IN1 – repetition of logic input DIG1	
8	AL4 - alarm 4	
9	AL1 or AL2	
10	AL1 or AL2 or AL3	
11	AL1 or AL2 or AL3 or AL4	
12	AL1 and AL2	
13	AL1 and AL2 and AL3	
14	AL1 and AL2 and AL3 and AL4	
15	AL1 or AL.HB or POWER_FAULT with HB alarm (TA1 OR TA2 OR TA3)	
16	AL1 or AL2 or (AL.HB or POWER_FAULT) with HB alarm (TA1 OR TA2 OR TA3)	
17	AL1 and (AL.HB or POWER_FAULT) with HB alarm (TA1 OR TA2 OR TA3)	
18	AL1 and AL2 and (AL.HB or POWER_FAULT) with HB alarm (TA1 OR TA2 OR TA3)	
19	AL.HB - HB alarm (TA2)	
20	AL.HB - HB alarm (TA3)	
21	Setpoint power alarm	
22	AL.HB - HB alarm (TA1)	
23	POWER_FAULT	
24	IN2 - repetition of logic input DIG2	
64	HEAT (heating control output) with fast cycle time 0.1 ... 20.0sec. / in case of continuous output 4...20mA / 2...10V	
65	COOL (cooling control output) with fast cycle time 0.1 ... 20.0sec. / in case of continuous output 4...20mA / 2...10V	

166	rL.3	R/W	Allocation of reference signal
170	rL.4	R/W	Allocation of reference signal
171	rL.5	R/W	Allocation of reference signal
172	rL.6	R/W	Allocation of reference signal

Value	Function	
2	AL1 - alarm 1	2
3	AL2 - alarm 2	
4	AL3 - alarm 3	
5	AL.HB or POWER_FAULT w/ HB alarm (TA1 OR TA2 OR TA3)	35
6	LBA - LBA alarm	
7	IN1 - repetition of logic input DIG1	
8	AL4 - alarm 4	4
9	AL1 or AL2	
10	AL1 or AL2 or AL3	
11	AL1 or AL2 or AL3 or AL4	
12	AL1 and AL2	160
13	AL1 and AL2 and AL3	
14	AL1 and AL2 and AL3 and AL4	
15	AL1 or AL.HB or POWER_FAULT with HB alarm (TA1 OR TA2 OR TA3)	
16	AL1 or AL2 or (AL.HB or POWER_FAULT) with HB alarm (TA1 OR TA2 OR TA3)	
17	AL1 and (AL.HB or POWER_FAULT) with HB alarm (TA1 OR TA2 OR TA3)	
18	AL1 and AL2 and (AL.HB or POWER_FAULT) with HB alarm (TA1 OR TA2 OR TA3)	
19	AL.HB - HB alarm (TA2)	
20	AL.HB - HB alarm (TA3)	
21	Setpoint power alarm	
22	AL.HB - HB alarm (TA1)	
23	POWER_FAULT	
24	IN2 - repetition of logic input DIG2	

+ 32 for logic level denied in output
+ 128 to force output to zero

Read State

308 319		R	State of outputs rL.x MASKOUT
------------	--	---	-------------------------------

0 ... 63	Table of output states
Bit	
0	State rL.1
1	State rL.2
2	State rL.3
3	State rL.4
4	State rL.5
5	State rL.6

12 Bit	STATE rL.1	R	OFF = Output off ON = Output on
13 Bit	STATE rL.2	R	OFF = Output off ON = Output on
14 Bit	STATE rL.3	R	OFF = Output off ON = Output on
15 Bit	STATE rL.4	R	OFF = Output off ON = Output on
16 Bit	STATE rL.5	R	OFF = Output off ON = Output on
17 Bit	STATE rL.6	R	OFF = Output off ON = Output on

Allocation of Physical Outputs

607	out . 1	R/W	Allocation of physical output OUT 1
608	out . 2	R/W	Allocation of physical output OUT 2
609	out . 3	R/W	Allocation of physical output OUT 3
610	out . 4	R/W	Allocation of physical output OUT 4
611	out . 5	R/W	Allocation of physical output OUT 5
612	out . 6	R/W	Allocation of physical output OUT 6
613	out . 7	R/W	Allocation of physical output OUT 7
614	out . 8	R/W	Allocation of physical output OUT 8
615	out . 9	R/W	Allocation of physical output OUT 9
616	out . 10	R/W	Allocation of physical output OUT 10

Table of output allocations		1	
0	Output disabled	2	
1	Output rL.1 zone 1		
2	Output rL.1 zone 2	3	
3	Output rL.1 zone 3		
4	Output rL.1 zone 4	4	
5	Output rL.2 zone 1		
6	Output rL.2 zone 2		
7	Output rL.2 zone 3		
8	Output rL.2 zone 4	5	
9	Output rL.3 OR rL.5 zone 1		
10	Output rL.3 OR rL.5 zone 2	6	
11	Output rL.3 OR rL.5 zone 3		
12	Output rL.3 OR rL.5 zone 4	7	
13	Output rL.4 AND rL.6 zone 1		
14	Output rL.4 AND rL.6 zone 2		
15	Output rL.4 AND rL.6 zone 3		
16	Output rL.4 AND rL.6 zone 4	8	
17	Output (rL.3 OR rL.5) zone 1...zone 4		
18	Output (rL.4 AND rL.6) zone 1...zone 4		
+32 to reverse output status only for Logic and Relay output			
NOTE: In 3-phase configuration, the state of physical output OUT1 is copied to OUT2 and OUT3.			17
In case of COOL OUTPUT (5,6,7,8) are continuous, the same output functions can not be used on other outputs. Ex: If out.1 = 1 (out rL.1 zone 1) it is not possible to set out.5 with the same code, if out.5 is continuous			18

Read State

82 Bit	State of output OUT 1	R	OFF = Output off ON = Active Output
83 Bit	State of output OUT 2	R	OFF = Output off ON = Active Output
84 Bit	State of output OUT 3	R	OFF = Output off ON = Active Output
85 Bit	State of output OUT 4	R	OFF = Output off ON = Active Output
86 Bit	State of output OUT 5	R	OFF = Output off ON = Active Output
87 Bit	State of output OUT 6	R	OFF = Output off ON = Active Output
88 Bit	State of output OUT 7	R	OFF = Output off ON = Active Output
89 Bit	State of output OUT 8	R	OFF = Output off ON = Active Output
90 Bit	State of output OUT 9	R	OFF = Output off ON = Active Output
91 Bit	State of output OUT 10	R	OFF = Output off ON = Active Output

664	R	State of outputs	Bit	
			0	OUT 1
			1	OUT 2
			2	OUT 3
			3	OUT 4
			4	OUT 5
			5	OUT 6
			6	OUT 7
			7	OUT 8
			8	OUT 9
			9	OUT 10

Functional Diagram

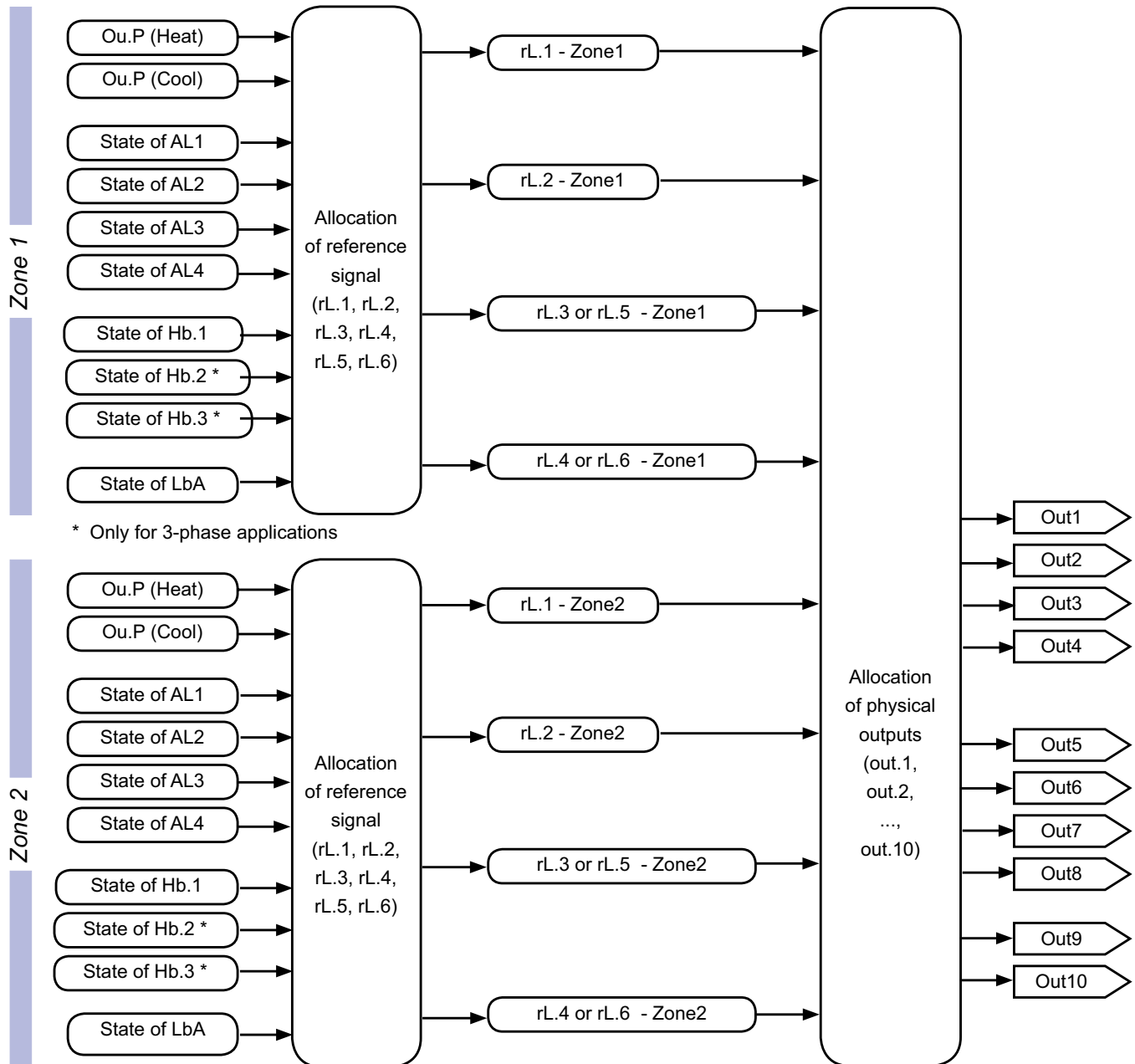

Settings

Setting the Setpoint

The active (control) setpoint (SPA) can be set by means of the local setpoint (_SP) or the remote setpoint (SP.rS). A remote setpoint can assume the value of an auxiliary input or one set via serial line (SP.r).

The remote setpoint can be defined in absolute value or relative to the local setpoint; in the latter case, the control setpoint will be given by the algebraic sum of the set local and the remote setpoint.

Enable Alarm

138 16-472	SP	R/W	Local Setpoint	Lo.L....Hi.L	0
---------------	----	-----	----------------	--------------	---

Remote Setpoint

181	tP.2	R/W	Auxiliary analog input function	See: AUXILIARY ANALOG INPUT (LIN/TC)	0
-----	------	-----	---------------------------------	--------------------------------------	---

The remote setpoint can be set by means of the auxiliary analog input by enabling the function with parameter tP.2

18 136-249	SP.r	R/W	Remote setpoint (SET gradient for manual power correction)	<table border="1"> <thead> <tr> <th colspan="2">Setpoint Table</th> <th>0</th> </tr> <tr> <th>Type of Remote Set</th> <th>Absolute/Relative</th> <th></th> </tr> </thead> <tbody> <tr> <td>0</td> <td>Digital (from serial line)</td> <td>Absolute</td> </tr> <tr> <td>1</td> <td>Digital (from serial line)</td> <td>Relative to local set (_SP o SP1 o SP2)</td> </tr> <tr> <td>2</td> <td>Auxiliary input</td> <td>Absolute</td> </tr> <tr> <td>3</td> <td>Auxiliary input</td> <td>Relative to set (_SP o SP1 o SP2)</td> </tr> </tbody> </table>	Setpoint Table		0	Type of Remote Set	Absolute/Relative		0	Digital (from serial line)	Absolute	1	Digital (from serial line)	Relative to local set (_SP o SP1 o SP2)	2	Auxiliary input	Absolute	3	Auxiliary input	Relative to set (_SP o SP1 o SP2)	0
Setpoint Table		0																					
Type of Remote Set	Absolute/Relative																						
0	Digital (from serial line)	Absolute																					
1	Digital (from serial line)	Relative to local set (_SP o SP1 o SP2)																					
2	Auxiliary input	Absolute																					
3	Auxiliary input	Relative to set (_SP o SP1 o SP2)																					

- +4 set gradient in digit/sec.
- +8 manual power correction based on line voltage
- +16 disables saving of local setpoint _SP
- +32 disables saving of local manual power (at switch-off, returns to last value saved)

Shared Settings

25 20-28-142	Lo.L	R/W	Lower settable limit SP, SP.1, SP.2, SP remote	Lo.S....Hi.S	0																											
26 21-29-143	Hi.L	R/W	Upper settable limit SP, SP.1, SP.2, SP remote	Lo.S....Hi.S	1000																											
10 bit	LOCAL/REMOTE	R/W	Instrument State (STATUS_W)	<table border="1"> <thead> <tr> <th colspan="2">Table of Instrument Settings</th> <th>0</th> </tr> <tr> <th>Bit</th> <th></th> <th></th> </tr> </thead> <tbody> <tr> <td>0</td> <td>-</td> <td></td> </tr> <tr> <td>1</td> <td>Select SP1/SP2</td> <td></td> </tr> <tr> <td>2</td> <td>Start/Stop Selftuning</td> <td></td> </tr> <tr> <td>3</td> <td>Select ON/OFF</td> <td></td> </tr> <tr> <td>4</td> <td>Select AUTO/MAN</td> <td></td> </tr> <tr> <td>5</td> <td>Start/Stop Autotuning</td> <td></td> </tr> <tr> <td>6</td> <td>Select LOC/REM</td> <td></td> </tr> </tbody> </table>	Table of Instrument Settings		0	Bit			0	-		1	Select SP1/SP2		2	Start/Stop Selftuning		3	Select ON/OFF		4	Select AUTO/MAN		5	Start/Stop Autotuning		6	Select LOC/REM		0
Table of Instrument Settings		0																														
Bit																																
0	-																															
1	Select SP1/SP2																															
2	Start/Stop Selftuning																															
3	Select ON/OFF																															
4	Select AUTO/MAN																															
5	Start/Stop Autotuning																															
6	Select LOC/REM																															
305		R/W	Instrument State																													

Read Active Setpoint

1 137-481	SPA	R	Active Setpoint
4		R	Deviation (SPA-PV)

Setpoint Control

Set Gradient

The “Set Gradient” function sets a gradual variation of the setpoint, with programmed speed, between two defined values. If this function is active (G.SP other than 0), at switch-on and at auto/man switching the initial setpoint is assumed equal to the PV, and the local or selected set is reached with set gradient. Every variation of set, including variations of the local setpoint, is subject to the gradient. The value of remote setpoint SP.rS is not saved in eeprom.

The set gradient is inhibited at switch-on when self-tuning is enabled.

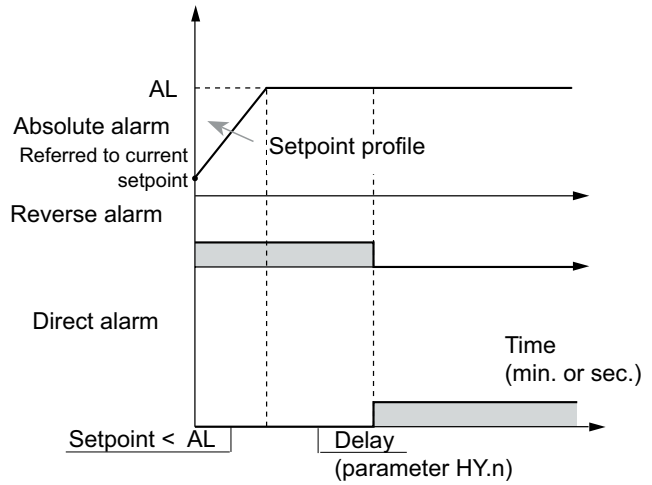

234 22	G.SP	R/W	Set gradient	0.0 ...999.9 digit / min (digit / sec see SP.r)	0.0
259	G.S2	R/W	Set gradient relative to SP2	0.0 ...999.9 digit / min (digit / sec see SP.r)	0.0

265	Hot	R/W	Select specialized control functions	Table of Specialized Control	0																																				
				<table border="1"> <thead> <tr> <th></th> <th>Enable</th> <th>Fault Action Power if PV is not stabilized</th> <th>Enable Preheating softstart</th> </tr> </thead> <tbody> <tr> <td>0</td> <td></td> <td>FA.P</td> <td></td> </tr> <tr> <td>1</td> <td>X</td> <td>Average power</td> <td></td> </tr> <tr> <td>2</td> <td></td> <td>FA.P</td> <td></td> </tr> <tr> <td>3</td> <td>X</td> <td>FA.P</td> <td></td> </tr> <tr> <td>4</td> <td></td> <td>FA.P</td> <td>X</td> </tr> <tr> <td>5</td> <td>X</td> <td>Average power</td> <td>X</td> </tr> <tr> <td>6</td> <td></td> <td>FA.P</td> <td>X</td> </tr> <tr> <td>7</td> <td>X</td> <td>FA.P</td> <td>X</td> </tr> </tbody> </table>		Enable	Fault Action Power if PV is not stabilized	Enable Preheating softstart	0		FA.P		1	X	Average power		2		FA.P		3	X	FA.P		4		FA.P	X	5	X	Average power	X	6		FA.P	X	7	X	FA.P	X	
	Enable	Fault Action Power if PV is not stabilized	Enable Preheating softstart																																						
0		FA.P																																							
1	X	Average power																																							
2		FA.P																																							
3	X	FA.P																																							
4		FA.P	X																																						
5	X	Average power	X																																						
6		FA.P	X																																						
7	X	FA.P	X																																						

FA.P – see alarm for probe in short or connection error (SBR-ERR)
+8 enable GS.2

Multiset

The MULTiset function determines the local setpoint by selecting the value from Setpoint (SP.1) or from Setpoint 2 (SP.2) based on the state of a digital input or by setting from a serial line.

The variation between Setpoint 1 and Setpoint 2 can take place with gradient: parameter G.SP determines the speed for reaching Setpoint 1 and parameter G.S2 defines the speed for reaching Setpoint 2.

The MULTiset function is enabled with parameter hd.1 and automatically enables the gradient function. Selection between Setpoint 1 and Setpoint 2 can be seen by means of LED.

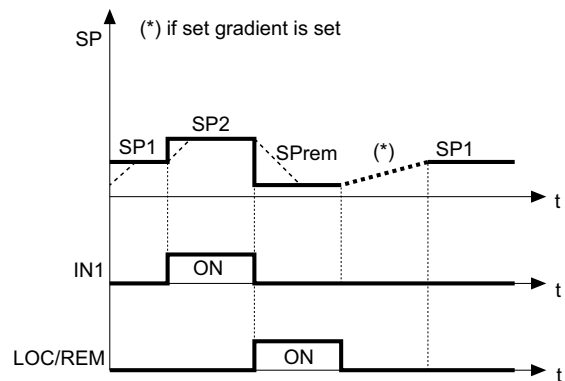

191	hd.1	R/W	Enable multiset: control instruments via serial	Multiset table		0.0
					Enable Multiset	Enable Virtual Instrument
				0		
				1	X	
				2		X
				3	X	X
230 482	SP.1	R/W	Setpoint 1	Lo.L...HI.L		100
231 483	SP.2	R/W	Setpoint 2	Lo.L...HI.L		200
140	d1G.	R/W	Digital Input Function	See: Table of digital input functions		0
618	d1G.2	R/W	Digital Input Function 2	See: Table of digital input functions		0
75 bit	Select SP1 / SP2	R/W	OFF = Select SP1 ON = Select SP2			
305		R/W	Instrument state (STATUS_W)	Table of instrument settings		0
				Bit		
				0	-	
				1	Select SP1/SP2	
				2	Start/Stop Selftuning	
				3	Select ON/OFF	
				4	Select AUTO/MAN	
				5	Start/Stop Autotuning	
				6	Select LOC/REM	

Functional Diagram

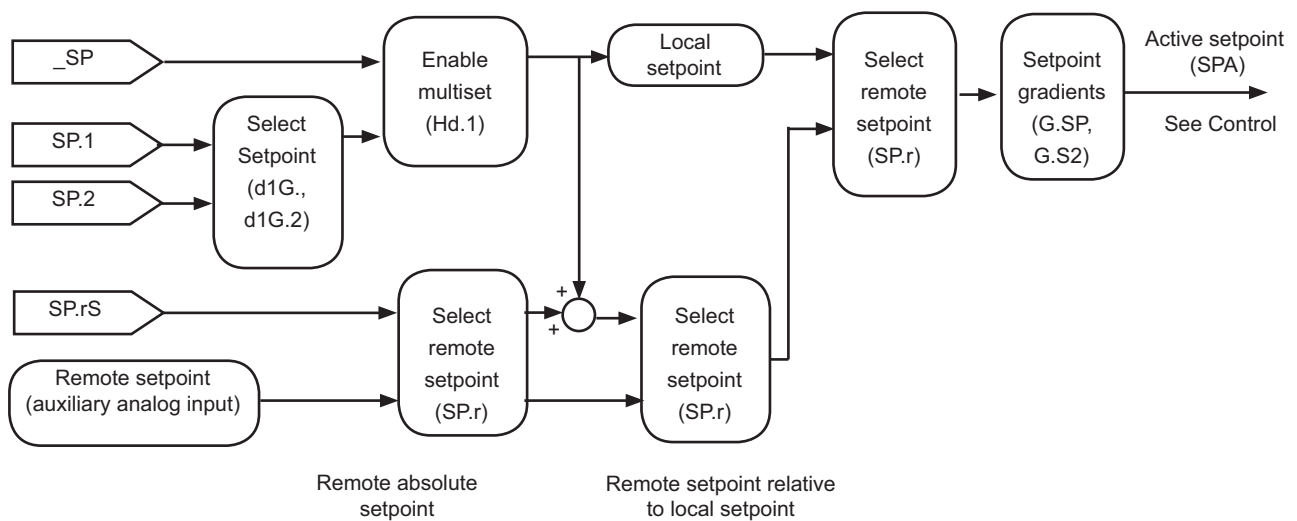

Controls

The C4 Family of controls are PID controllers. PID is proportional, integral, and derivative math functions that when properly set will provide a highly accurate and stable control for the process. The C4 controllers can be set for heating or cooling or both heat & cool. See below for further information on heating & cooling used together.

It is usually recommended to use one of the three built-in Autotuning or Selftuning functions for determining

the initial PID parameters. There are two types of Autotuning, Continuous & One-Shot. These tuning functions need to be enabled within the C4 controller.

The PID values can be read and manually adjusted should fine tuning or specific user preferences for the process are needed. In this document is a method of manual tuning if the user is unable to find satisfactory control via the autotuning or selftuning functions.

Heat/Cool Control with Separate or Superimposed Band

Output with separate band

Control output with only proportional action in case of proportional heating band separate from cooling band.

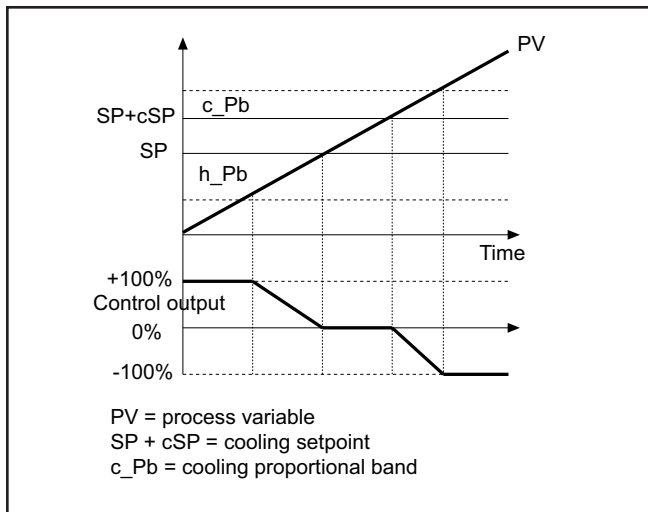

Output with superimposed band

Control output with only proportional action in case of proportional heating band superimposed on cooling band.

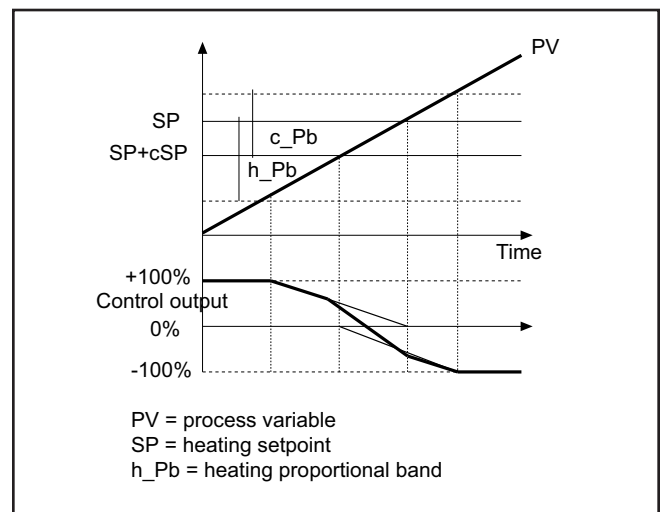

Heat/Cool Control with Relative Gain

This control mode (enabled with parameter Ctr = 14) asks you to specify cooling type. The PID cooling parameters are then calculated based on heating parameters in the ratio specified (ex: C.ME = 1 (oil), H_Pb = 10, H_dt = 1, H_It = 4 implies:

C_Pb = 12.5, C_dt = 1, C_It = 4)

Apply the following values when setting cycle times:

Air T Cool cycle = 10 sec.

Oil T Cool cycle = 4 sec.

Water T Cool cycle = 2 sec.

NB.: Cool parameters cannot be changed in this mode.

PID Parameters

617	SPU	R/W	Selection of process variable of zone / Zone reference power	Table of Selections			
				1	2	3	4
				Zone 1	Zone 2	Zone 3	Zone 4
				1	PV zone 1		
				2	PV zone 2		
				3	PV zone 3		
				4	PV zone 4		
				9	POWER zone 1 (*)		
				10	POWER zone 2 (*)		
				11	POWER zone 3 (*)		
				12	POWER zone 4 (*)		

(*):

- The reference power of a slave zone in automatic mode is the power of a master zone in automatic or manual mode.
- The reference power of a slave zone in manual mode is the zone manual power.
- Software shutdown remains independent for each zone.

180	Ctrl	R/W	Control Type	Table of Heat/Cool Controls					6
				0	P heat				
				1	P cool				
				2	P heat / cool				
				3	PI heat				
				4	PI cool				
				5	PI heat / cool				
				6	PID heat				
				7	PID cool				
				8	PID heat / cool				
				9	ON-OFF heat				
				10	ON-OFF cool				
				11	ON-OFF heat / cool				
				12	PID heat + ON-OFF cool				
				13	ON-OFF heat + PID cool				
				14	PID heat + cool with relative gain (see parameter C.MEd)				

Select sample time for derivative action.
 +0 sample 1 sec.
 +16 sample 4 sec.
 +32 sample 8 sec.
 +64 sample 240 msec.
 +128 No Reset of integral component at setpoint change

Note: the LBA alarm is not enabled in the ON/OFF control.

WARNING: the Control ("Ctr") default parameter changed from "6" to "134" starting from products with serial number "SN 1013A1965" (March 2010).

The option "+128", used to disable the "Integral power reset" has been introduced as an improvement, starting from the Software version "1.43".

We strongly suggest to verify the eventual recipes created with Software versions before the 1.43, because, if the parameter "Ctr" is included in the recipe, it could be configured in an undesirable way.

5 148-149	h . Pb	R/W	Proportional band for heating or hysteresis ON/OFF	0.0 ...999.9% f.s.	1.0
7 150	h . It	R/W	Integral Heating Time	0.0 ...99.99 min	4.00

8 151	h.dt	R/W	Derivative Heating Time	0.0 ...99.99 min	1.00
6	c.Pb	R/W	Proportional band for cooling or hysteresis ON/OFF	0.0 ...999.9% f.s.	1.0
76	c.lt	R/W	Integral Cooling Time	0.00 ...99.99 min	4.00
77	c.dt	R/W	Derivative Cooling Time	0.00 ...99.99 min	1.00

Note: Parameters c.PB, c.lt and c.dt are read-only if heat/cool control is enabled with relative gain (Ctr = 14).

513	[.nE]	R/W	Select Cooling Fluid	0...2	Relative Gain (rG)	0	
					0	Air	1
					1	Oil	0.8
					2	Water	0.4
152 9	[t.1]	R/W	OUT 1 (Heat) cycle time	1 ...200 sec (0.1 ...20 sec)	Set 0 for GTT function 2 See POWER CONTROL	2	
159	[t.2]	R/W	OUT 2 (Heat) cycle time	1 ...200 sec (0.1 ...20 sec)		20	

Read State

The following registers are accessible via serial line:

2 132-471	0uP	R	Value of control outputs (+Heat/-Cool)	(W – only in manual mode at address 252)
--------------	-----	---	---	--

Advanced Settings

39 484	cSP	R/W	Cooling setpoint relative to heating setpoint	±25.0% f.s.	0.0
78	rSt	R/W	Manual reset (value added to PID input)	-999 ...999 scale points	0
516	P_rS	R/W	Reset power (value added directly to PID output)	-100.00....100.0 %	0.0
79	R_rS	R/W	Antireset (limits integral action of PID)	0 ...9999 scale points	0
80	FFd	R/W	Feedforward (value added to PID output after processing)	-100.00....100.0 %	0.0
42 146	hPh	R/W	Maximum limit heating power	0.0 ...100.0 %	100.0
254	hPL	R/W	Min. limit heating power (not available for double heat/cool action)	0.0 ...100.0 %	0
43	cPH	R/W	Maximum Limit Cooling Power	0.0 ...100.0 %	100.0
255	cPL	R/W	Min. limit cooling power (not available for double heat/cool action)	0.0 ...100.0 %	0.0
765	PPEr	R/W	Percentage of output power	0.0 ...100.0 %	100.0

Functional Diagram

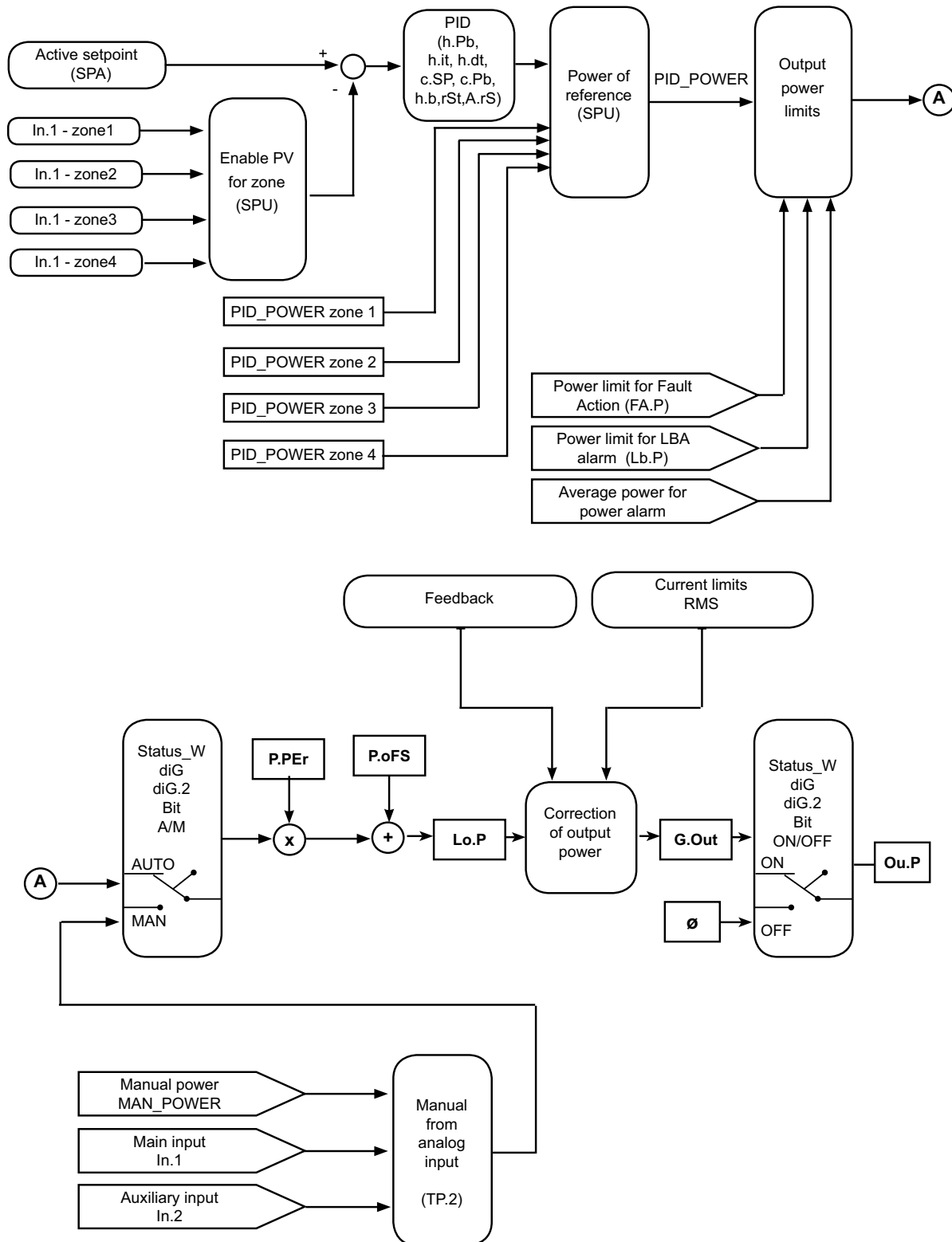

Automatic / Manual Control

By means of the digital input function you can set the controller in MAN (manual) and set the control output to a constant value changeable by means of communication.

When returning to AUTO (automatic), if the variable is within the proportional band, switching is bumpless.

2 132-471	ou.P	R	Value of control outputs (+Heat / -Cool)	(W—only in manual mode at address 252)	0
140	d i1	R/W	Digital Input Function	See: Table of digital input functions	0
618	d i2	R/W	Digital Input Function 2		
1 bit	AUTO/ MAN	R/W	OFF = Automatic ON = Manual		
305		R/W	Instrument State	See: Table of instrument settings	0

Hold Function

The process variable value and the setpoints remain “frozen” for the time the digital input is active.

By activating the digital input with the Hold function when the variable is at values below the setpoint, a setpoint memory reset de-energizes all energized relays and resets all memory latches.

140	d i1	R/W	Digital Input Function	See: Table of digital input functions	0
618	d i2	R/W	Digital Input Function 2		
64 Bit	HoLd	R/W	OFF = Disable Hold ON = Enable Hold		

Manual Power Correction

With this function (available on models with CV diagnostics option), you can run a correction of power delivered in manual based on the reference line voltage (riF). The % value of the (Cor) is freely settable and acts in inverse proportion.

The function is activated/deactivated by means of parameter SP.r.

Example: with the following settings: Cor = 10%; riF = 380; SP.r = value + 8; instrument in manual; line voltage 380 VAC, manual power set at 50%, following a 10% increase in line voltage, $380V + 10\% (380V) = 418V$, there is a decrease in set manual power equal to the same % of change: $50\% - 10\% (50\%) = 45\%$.

To use this function, the controller must have a CT (current transformer) and a VT (voltage transformer). N.B.: the % change in manual power is limited to the value set in parameter “Cor”.

The maximum manual power correction is limited to $\pm 65\%$.

505	r IF	R/W	Line Voltage	0.0 ...999.9	0.0
-----	------	-----	--------------	--------------	-----

Compensation of the voltage transformer read to maintain output power at a constant level.

506	Cor	R/W	Correction of manual power based on line voltage	0.0 ...100.0 %	0.0
-----	-----	-----	--	----------------	-----

18 136-249	SPr	R/W	Remote setpoint (SET gradient for manual power correction)	Setpoint Table	0
---------------	-----	-----	--	----------------	---

	Type of Remote Set	Absolute/Deviation
0	Digital (from serial line)	Absolute
1	Digital (from serial line)	Deviation local set (_SP o SP1 o SP2)
2	Auxiliary input	Absolute
3	Auxiliary input	Deviation set (_SP o SP1 o SP2)

+4 set gradient in digit/sec.
+8 correction of manual power based on line voltage
+16 disable saving of local setpoint _SP
+32 disable saving of local manual power (at switch-off returns to last value saved)

Manual Tuning

- Enter the setpoint at its working value.
- Set the proportional band at 0.1% (with on-off type setting).
- Switch to automatic and observe the behavior of the variable. It will be similar to that in the figure.
- The PID parameters are calculated as follows: Proportional band

$$P.B. = \frac{\text{Peak}}{V_{\max} - V_{\min}} \times 100$$

(V max - V min) is the scale range.

Integral time $I_t = 1.5 \times T$

Derivative time $d_t = I_t/4$

- Switch the controller to manual, set the calculated parameters (activate the PID control by setting a cycle time for relay outputs, if any), switch to automatic.
- To assess parameter optimization, change the setpoint value if possible and check temporary behavior. If oscillation persists, increase the value of the proportional band; if response is too slow, decrease the value.

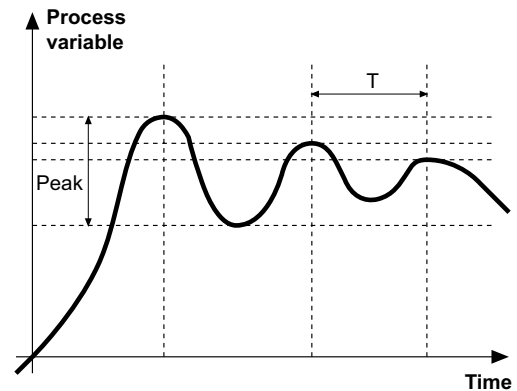

See: CONTROL - PID Parameters

Autotuning

Enabling the autotuning function blocks the settings of the PID parameters.

Autotuning continues to measure the system oscillations, seeking as quickly as possible the PID parameter values that reduce the oscillation; it does not intervene if the oscillations drop to values below 1.0% of the proportional band.

It is interrupted if the setpoint is changed, and resumes automatically with a constant setpoint. The calculated parameters are not saved; if the instrument is switched off the controller resumes with the parameters programmed before autotuning was enabled.

Autotuning terminates the procedures with switching to manual.

Enabling the autotuning function blocks the settings of the PID parameters.

It can be two types: continuous or one shot.

Continuous autotuning is enabled with parameter *Stu* (values 1, 3, 5); it continues to measure the system oscillations, seeking as quickly as possible the PID parameter values that reduce the oscillation; it does not intervene if the oscillations drop to values below 1.0% of the proportional band.

It is interrupted if the setpoint is changed, and resumes automatically with a constant setpoint.

The calculated parameters are not saved if the instrument is switched off, in case of switching to manual or disabling the code in configuration, and controller resumes with the parameters programmed before autotuning was enabled.

The calculated parameters are saved when the function is enabled via digital input or via A/M key (start / stop) at stop.

One-shot autotuning can be activated manually or automatically with parameter *Stu* (as can be seen on the table, the values to be set depend on enabling of Self-tuning or Softstart).

It is useful for calculating PID parameters when the system is in the vicinity of the setpoint; it produces a variation on the control output of a maximum of $\pm 100\%$ of the current control power limited by h.PH - h.PL (heat), c.PH - c.PL (cool) and assesses the effects in overshoot over time. The calculated parameters are saved.

Manual activation (code *Stu* = 8, 10, 12) by setting the parameter directly or via digital input or key.

Automatic activation (code *Stu* = 24, 26, 28 with error range of 0.5%) when the PV-SP error exceeds the defined range (programmable at 0.5%, 1%, 2%, 4% of full scale).

Activation is inhibited if PV <5% or PV >95% of input scale.



NB: at switch-on after selftuning, after switching to MANUAL, after software shutdown or after a setpoint change, automatic activation is inhibited for an interval equal to five times the integral time, with a minimum of 5 minutes.

An identical interval has to lapse after a one-shot run.

See: CONTROL - PID Parameters

31	Stu	R/W	Enable selftuning, autotuning, softstart	Selftuning, autotuning, softstart table			0
S.tu	Autotuning continuous	Selftuning	SoftStart				
0	NO	NO	NO				
1	YES	NO	NO				
2	NO	YES	NO				
3	YES	YES	NO				
4	NO	NO	YES				
5	YES	NO	YES				
6	-	-	-				
7	-	-	-				
8*	WAIT	NO	NO				
9	GO	NO	NO				
10*	WAIT	YES	NO				
11	GO	YES	NO				
12*	WAIT	NO	YES				
13	GO	NO	YES				

(*) +16 with automatic switching in GO if PV-SP > 0.5% f.s.
 +32 with automatic switching in GO if PV-SP > 1% f.s.
 +64 with automatic switching in GO if PV-SP > 2% f.s.
 +128 with automatic switching in GO if PV-SP > 4% f.s.

140		R/W	Digital Input Function	See: Table of digital input functions	0.0
618		R/W	Digital Input 2 Function		0.0
29 bit	AUTOTUNING	R/W	OFF = Stop Autotuning ON = Start Autotuning		

Read State

28 bit	AUTOTUNING STATE	R	OFF = Autotuning in Stop ON = Autotuning in Start		
68 bit	DIGITAL INPUT 1	R	OFF = Digital input 1 off ON = Digital input 1 on	See: Table of digital input functions	
92 bit	DIGITAL INPUT 2	R	OFF = Digital input 2 off ON = Digital input 2 on		
296			Autotuning and selftuning enable state (FLG_PID)		0
				Bit	
				3	Selftuning On
				6	Autotuning On
305		R/W	Instrument state	Table of instrument settings	0
				Bit	
				0	-
				1	Select SP1/SP2
				2	Start/Stop Selftuning
				3	Select ON/OFF
				4	Select AUTO/MAN
				5	Start/Stop Autotuning
				6	Select LOC/REM

Selftuning

This function is valid for single-action (either heat or cool) systems and for double-action (heat/cool) systems.

Selftuning is activated to calculate the best control parameters when starting the process. The variable (example:

temperature) must be the one assumed at zero power (room temperature).

The controller supplies the maximum power set until reaching an intermediate point between starting value and the setpoint, then resets power. The PID parameters are calculated by evaluating superelongation and the time needed to reach the peak (N.B.: This action is not considered in ON/OFF control).

When the function is completed, it disengages automatically, and the control proceeds to reach the setpoint.

How to activate selftuning:

- A. Activation at switch-on
 1. Set the setpoint to the desired value.
 2. Enable selftuning by setting parameter Stu to 2
 3. Switch off the instrument.
 4. Make sure that temperature is near room temperature.
 5. Switch on the instrument.
- B. Activation via serial command
 1. Make sure that temperature is near room temperature.
 2. Set the setpoint to the desired value.
 3. Run the Start Selftuning command.

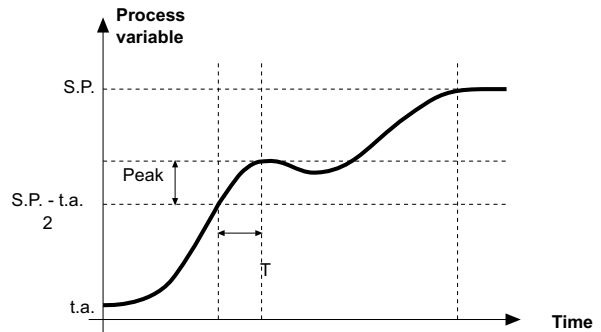

The procedure runs automatically until termination. At termination, the new PID parameters are saved: proportional band, integral and derivative times calculated for the current action (heat or cool). In case of double action (heat + cool), the parameters for the opposite action are calculated by maintaining the initial ratio between the parameters (example: $C_{pb} = H_{pb} * K$; where $K = C_{pb} / H_{pb}$ when selftuning is started). At termination, the Stu code is automatically cancelled.

Note: The procedure does not start if temperature exceeds the setpoint for heat control, or is below the setpoint for cool control.

In this case, the Stu code is not cancelled. It is advisable to enable the LEDs to signal selftuning state. By setting parameter Ld.St = 4 on the Hrd menu, the appropriate LED will light up or flash when selftuning is active.

31	Stu	R/W	Enable selftuning, autotuning, softstart	0
			Selftuning, autotuning, softstart table	
			Autotuning continuous	Selftuning
			SoftStart	
0			NO	NO
1			YES	NO
2			NO	YES
3			YES	YES
4			NO	NO
5			YES	NO
6			-	-
7			-	-
8*			WAIT	NO
9			GO	NO
10*			WAIT	YES
11			GO	YES
12*			WAIT	NO
13			GO	YES

(*) +16 with automatic switching in GO if PV-SP > 0.5% f.s.
 +32 with automatic switching in GO if PV-SP > 1% f.s.
 +64 with automatic switching in GO if PV-SP > 2% f.s.
 +128 with automatic switching in GO if PV-SP > 4% f.s.

140		R/W	Digital Input Function	See: Table of digital input functions	0.0
618		R/W	Digital Input 2 Function		0.0
3 bit	SELFTUNING	R/W	OFF = Selftuning in Stop ON = Selftuning in Start		
305		R/W	Instrument state	Table of instrument settings	0

Read State

0 bit	SELFTUNING STATE	R	OFF = Selftuning in Stop ON = Selftuning in Start		
68 bit	Digital Input 1	R	OFF = Digital input 1 off ON = Digital input 1 on	See: Table of digital input functions	
92 bit	Digital Input 2	R	OFF = Digital input 2 off ON = Digital input 2 on		
296		R	Autotuning and selftuning enable state (FLG_PID)		0
	Bit				
	3		Selftuning On		
	6		Autotuning On		

Soft Start

If enabled, this function partializes power based on a percentage of time elapsed since instrument switch-on compared to the set time of 0.0 ... 500.0 min ("SoFt" parameter CFG phase). Softstart is an alternative to selftuning and is activated after each instrument switch-on. Softstart is reset when switching to manual.

31		R/W	Enable selftuning, autotuning, softstart	Selftuning, autotuning, softstart table	0		
				Autotuning continuous	Selftuning	SoftStart	
				0	NO	NO	
				1	YES	NO	NO
				2	NO	YES	NO
				3	YES	YES	NO
				4	NO	NO	YES
				5	YES	NO	YES
				6	-	-	-
				7	-	-	-
				8*	WAIT	NO	NO
				9	GO	NO	NO
				10*	WAIT	YES	NO
				11	GO	YES	NO
				12*	WAIT	NO	YES
				13	GO	NO	YES

(*) +16 with automatic switching in GO if PV-SP > 0.5% f.s.
+32 with automatic switching in GO if PV-SP > 1% f.s.
+64 with automatic switching in GO if PV-SP > 2% f.s.
+128 with automatic switching in GO if PV-SP > 4% f.s.

263		R/W	Softstart setpoint		0
264		R/W	Softstart power	-100,00....100,0 %	0.0
147		R/W	Softstart Time	0.0 ...500.0 min	0.0

Read State

63 bit	STATE SOFTSTART	R	OFF = Softstart in Stop ON = Softstart in Start
--------	-----------------	---	--

Start Mode

699	Point	R/W	Start modes at Power-On		0
				0*	Function at previous state
				1	Software shutdown
				2	Software startup

(*) digital input states always have priority

Software Shutdown

Running the software shutdown procedure causes the following:

- 1) Reset of Autotuning, Selftuning and Softstart.
- 2) Digital input (if present) enabled only if assigned to SW shutdown function.
- 3) In case of switch-on after SW shutdown, any ramp for the set (set gradient) starts from the PV.
- 4) Outputs OFF: except for rL.4 and rL.6 which are forced ON.
- 5) Reset of HB alarm.
- 6) Reset of LBA alarm.
- 7) The Heat and Cool bit on the state word STATUS_STUMENTO and POWER are reset.
- 8) At shutdown, the current power is saved. At switch-on, integral power is recalculated as the difference between saved power and proportional power; this calculation is defined as “desaturation at switch-on.”
- 9) Alarms AL1 ...AL4 can be enabled or disabled by the OFF.t parameter.

140	d i	R/W	Digital Input Function	See: Table of digital input functions	0.0
618	d i2	R/W	Digital Input 2 Function		0.0
11 bit	SOFTWARE LAUNCH/SHUTDOWN	R/W	OFF = ON ON = OFF		
700	OFFt	R/W	Modes at software shutdown	0 Outputs rL.1- rL.2 - rL.3 - rL.5 = OFF Outputs rL.4 - rL.6 = ON Alarms AL.1 -AL.2 -AL.3 - AL.4 disabled	0
				1 Outputs rL.1- rL.2 - rL.3 - rL.5 = OFF Outputs rL.4 - rL.6 = ON Alarms AL.1 -AL.2 -AL.3 - AL.4 enabled	
				+16 Restart of the Softstart at the switch-on software (ON Software)	

Read State

68 bit	DIGITAL INPUT 1	R	OFF = Digital input 1 off ON = Digital input 1 on	See: Table of digital input functions	
92 bit	DIGITAL INPUT 2	R	OFF = Digital input 2 off ON = Digital input 2 on		
305		R/W	Instrument state	See: Table of instrument settings	0

Specialized Control Functions

These settings are available for fast acting systems that have a tendency for the main sensor to break but it is desirable that the controller continue to operate in manual mode. Settings for fast cycle times down to 0.1 second can be set. A suitable application would be Hot Runner control in plastics molding presses.

The main functions are:

Sensor Fault Action SBR; Power Setting

In the case of a SBR, sensor break or fault, then the user can decide the controls action of the % output.

Using the “HOT” (address 265) the user decides the control action. The choice is a pre-decided user % output “FA.P” (address 228) or an Average % power output. The Average % Power output calculation is discussed in the next section titled POWER ALARM.

The alarm reset and reference power update take place only at switch-on or after a setpoint change.

The alarm is not activated if the control (CTR) is ON/OFF type, during Selftuning and in Manual.

265	Hot	R/W	Select Specialized Control Functions	Table of specialized control functions			0
	Hot		Enable Specialized Control		Fault Action Power if PV is not stabilized	Enable Preheating softstart	
	0				FA.P		
	1		X		Average power		
	2				FA.P		
	3		X		FA.P		
	4				FA.P	X	
	5		X		Average power	X	
	6				FA.P	X	
	7		X		FA.P	X	
+8 enable GS.2							

FA.P – see alarm for probe in short or connection error (SBR-ERR)

228	FA.P	R/W	Fault Action Power (supplied in conditions of broken probe)	-100.0 ..100.0 %		0.0
-----	------	-----	---	------------------	--	-----

Read State

26	Bit	HB ALARM STATE OR POWER_FAULT	R	OFF = Alarm off ON = Alarm on
80		State of Power alarm	R	OFF = Alarm off ON = Alarm on

Power Alarm

The Power Alarm is used in the Specialized Control Function to monitor, then alarm, when the output power deviates outside an average calculated power band (Average Power +/- b.PF) for greater than the delay time “PF.t” (address 260). See diagram.

The Power Alarm is settings are based upon the average % power output. This average % power output is automatically calculated by the C4. The calculation is made when the Process Variable has stabilized within Setpoint and user set band “b.St”(address 261) for 5 minutes. Note that the user must enable this alarm in “Hot” (address 265).

The alarm is not activated if the control (Ctr) is ON/OFF type, during Selftuning and in Manual.

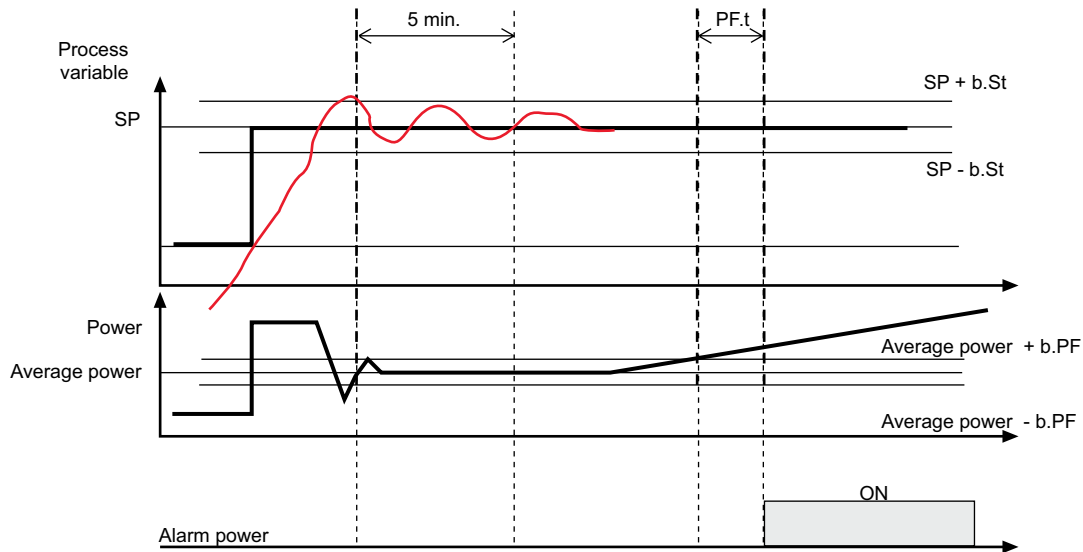

The parameters for alarm power are:

261	bSt	R/W	Stability Band (specialized control alarm power function)	0.0 ...100.0 % f.s.	0.0
262	bPF	R/W	Alarm Power Band (specialized control alarm power function)	0.0 ...100.0 %	0.0
260	PFt	R/W	Delay Time for alarm power activation (specialized controls)	0 ...999 sec	0
160	rL1	R/W	Allocation of reference signal	See: Generic alarms –Table of reference signals	0
163	rL2	R/W	Allocation of reference signal		1
166	rL3	R/W	Allocation of reference signal - OR output		2
170	rL4	R/W	Allocation of reference signal - AND Output		35
171	rL5	R/W	Allocation of reference signal - OR output		4
172	rL6	R/W	Allocation of reference signal - AND Output		160

Setting up the Power Alarm Function

If using a relay output the assign an output (rL.2...6) for the power alarm.

Set the band (b.ST) within which the process variable is considered stable after 300 sec. have elapsed.

Set the band (b.PF) outside which the alarm is activated after time PF.t has elapsed.

Note: The reference for average power is the active power after 5 minutes (300 sec). have elapsed.

The alarm reset and reference power updates only take place only at switch-on or after a setpoint change.

The alarm is not activated if the control (Ctr) is ON/OFF type, during Selftuning and in Manual.

If the process variable leaves the stabilization band after the first stabilization, this does not influence the power alarm status.

In case of SBR, Sensor Break, 1) if the PV has not yet stabilized, either the average power over the last 5 minutes or FAP power is supplied (depending on the setting of the HOT parameter), or 2) if the PV has stabilized the average power over the last 5 minutes is supplied.

Softstart for Preheating

This function allows the controller to pre-heat at specific setpoint or via a power & time setting. Once finished the control re-sumes its normal PID control settings.

Softstart becomes active only at switch-on, with manual-automatic switching during Softstart (the time restarts from 0), and if the process variable is below setpoint S.P.S.

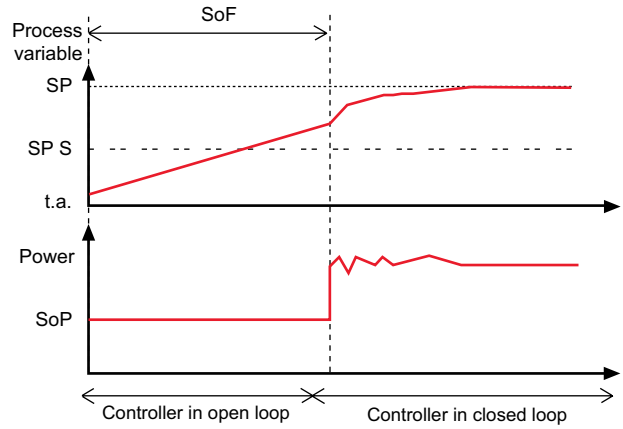

265	Hot	R/W	Select Specialized Control Functions	Table of specialized control functions	0
-----	-----	-----	--------------------------------------	--	---

Hot	Enable Specialized Control	Fault Action Power if PV is not stabilized	Enable Preheating softstart
0		FA.P	
1	X	Average power	
2		FA.P	
3	X	FA.P	
4		FA.P	X
5	X	Average power	X
6		FA.P	X
7	X	FA.P	X
+8 enable GS.2			

FA.P – see alarm for probe in short or connection error (SBR-ERR)

263	SPS	R/W	Softstart setpoint	Lo.L...HI.L	0
264	SoP	R/W	Softstart power	-100.00....100.0 %	0.0
147	SoF	R/W	Softstart Time	0.0 ...500.0 min	0.0

Read State

63 bit	STATE OF SOFTSTART	R	OFF = Softstart in Stop ON = Softstart in Start
--------	--------------------	---	--

Heating Output (Fast cycle)

For outputs rL.1 (Out 1) and rL.2 (Out 2) you can set a fast cycle time (0.1 ... 20 sec) by setting the parameter to 64 (Heat) or 65 (Cool).

160	rL1	R/W	Allocation of reference signal	See: Generic alarms –Table of reference signals	0
163	rL2	R/W	Allocation of reference signal		1

Power Control

SSR Control Modes

The following models are available:

- C4 with full scale 16A in all four zones
- C4 with full scale 30A in all four zones
- C4 with full scale 40A in all four zones

C4X has four zones that will drive four logic outputs via VDC that will drive external SSR.

There are two power control modes. More graphical details located in the C4 Hardware Manual.

Zero Crossing Mode, ZC, settable cycle time (Ex: Ct.1 = 2sec if power Out.P = 50,0% output on for 1 second and output off for 1 second)

Burst Fire Mode, GTT, variable cycle time with power delivery optimised in packets with minimum duration of 20ms (GTT function)

(Ex: Ct.1 = 0 if power Out.P = 50,0% output on for 20ms and output off for 20ms).

In the first case, you can set the cycle time with two different resolutions, in seconds or in tenths of a second, based on the type of heating (heat) or cooling (cool) function assigned to outputs rL1 and rL2.

It is advisable to use short cycle times (< 2-3 sec.) in case of control by means of solid state devices (SSR).

Heuristic Control Power

Heuristic Control allows the user to control individual outputs timing to the limit the total peak power to the heating loads at any one time. This will help avoid over-all peak current draws in the entire machine when used in single phase power line.

When starting a machine from cold, all loads tend to turn on together at 100%. The power will stay at nearly 100% until temperatures begin to approach the set-point. Heuristic control will alternate the power

Condition for Heuristic Control is that the cycle time must be identical for all zones; the power percentage for each zone must be able to reach the desired set-point for the machine for startup, load changes, and process upsets.

Example 1:

4 loads 380V- 32A (zone 1), 16A (zone 2), 25A (zone 3), 40A (zone 4)

So maximum current is 113A, if all zones turn on together. $I1+I2+I3+I4 = 113A$

Current limit I.HEU=50A. I.HEU is address 681.

The following combinations of conduction are possible: (to define the number of combinations, remember that the combinations without repetitions are $= n! / (k!(n-k)!)$)

- $I1+I2 = 48A$
- $I1+I3 = 57A$
- $I1+I4 = 72A$
- $I2+I3 = 41A$
- $I2+I4 = 56A$
- $I3+I4 = 65A$
- $I1+I2+I3 = 73A$
- $I1+I2+I4 = 88A$
- $I2+I3+I4 = 81A$
- $I1+I3+I4 = 97A$
- $I1+I2+I3+I4 = 113A$

The combination corresponding to current values below the limit value of I.HEU 50A is:

- $I1+I2 = 48A$
- $I2+I3 = 41A$

The one with lower current is given by zone 2 and zone 3. In the single cycle time for the enabled zones, the delivery of power may be reduced to respect the maximum current limit. The time distribution for activation of the zones is calculated at the start of each cycle:

$$P_{tot} = P1 + P2 \text{ (if } P2 > P3) + P3 \text{ (if } P3 > P2) + P4$$

Simultaneity is allowed for zones 2 and 3.

If $P1 = 100\%$, $P2 = 100\%$, $P3 = 100\%$, $P4 = 100\%$

$P_{tot} = 300\%$; since $P_{tot} > 100\%$, the conduction time of the zone x is obtained by $Px * (100/P_{tot})$

The combination corresponding to current values below the limit value of I.HEU 50A is:

- $I1+I2 = 48A$
- $I2+I3 = 41A$

The one with lower current is given by zone 2 and zone 3. In the single cycle time for the enabled zones, the delivery of power may be reduced to respect the maximum current limit. The time distribution for activation of the zones is calculated at the start of each cycle:

$$P_{tot} = P1 + P2 \text{ (if } P2 > P3) + P3 \text{ (if } P3 > P2) + P4$$

Simultaneity is allowed for zones 2 and 3.

If $P1 = 100\%$, $P2 = 100\%$, $P3 = 100\%$, $P4 = 100\%$

$P_{tot} = 300\%$; since $P_{tot} > 100\%$, the conduction time of the zone x is obtained by $Px * (100/P_{tot})$

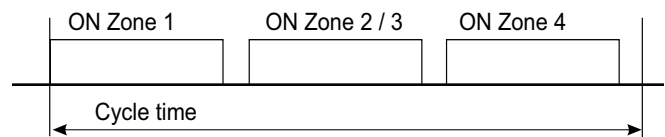

P1,2,3,4 delivered = 100%*0.33 = 33%

If P1= 100%, P2= 50%, P3= 0%, P4= 25%

Ptot=175%; since Ptot>100%, the conduction time of the zone x is obtained by Px * (100/Ptot)

P1 delivered = 100%*0.57 = 57%

P2 delivered = 50%*0.57 = 28.5%

P3 delivered = 0%*0.57 = 0%

P4 delivered = 25%*0.57 = 14.2%

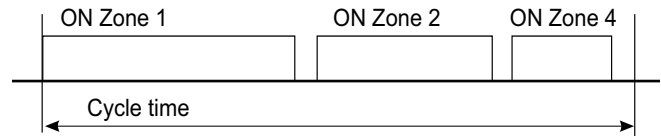

Heterogeneous Power Control

The purpose of this control is for the user to set an overall maximum current level to be used by the C4 or C4X. If the C4 senses an instantaneous exceeding the maximum current setting then the C4 will disconnect the zones based upon a preset priority.

This function resembles that of a thermal cutout that disconnects the load based on reading from the C4's four internal current transformers C4X four external current transformers. This function does not work with a single current transformer unit.

Example:

Zone 1 has priority: in case of overload, zone 4 is disconnected, followed by zone 3, etc.

The maximum total controllable current in four zones is 160A in a C4-404 (40A model). The maximum current in a single zone is 40A.

Example: Maximum Current set to 125A. The control heating element loads are three 40A loads and one 10A load. If all zones turn on at the same time with a total of 130A, then zone 4 is disconnected.

682	hd.4	R/W	Enable heterogeneous power control	Table for enabling heterogeneous power					0
HD.3	Zone 1	Zone 2	Zone 3	Zone 4					
0									
1	X								
2		X							
3	X	X							
4			X						
5	X		X						
6		X	X						
7	X	X	X						
8				X					
9	X			X					
10		X		X					
11	X	X		X					
12			X	X					
13	X		X	X					
14		X	X	X					
15	X	X	X	X					

NOTE: Only for C4's with CT's.

In case of C4X, the 4 CT's must be connected to outputs OUT1...OUT4

683	IHEE	R/W	Maximum current for heterogeneous power control	Heterogeneous power table	0
				0.0 ... 64.0 for C4 30 kW	
				0.0 ... 128.0 for C4 60 kW	
				0.0 ... 160.0 for C4 80 kW	

Virtual Instrument Control

Virtual Instrument Control allows some setting of inputs, outputs, and LED status through the serial communications port. An example could be a different control system that is collecting temperature information then transmits continuous temperature updates to the C4 to use instead of local thermocouple or RTD inputs.

Virtual instrument control is activated by means of parameter hd.1.

- By setting parameters S.In and S.Ou, this will enable the writing of some parameters via serial line, set the value of inputs and the state of outputs.

- Enabling alarm setpoints AL1, ..., AL4 when write operations are continuous, and you don't have to keep the last value in eeprom.
- Enabling the PV input, excludes the local Tc or RTD acquisition and replace it with the value written in the register VALUE_F.
- Enabling digital input IN lets you set the state of this input, for example to run MAN/AUTO switching with the writing of bit 7 in the register V_IN_OUT.
- Ability to set the on/off state of outputs OUT1, ..., OUT10 and of the LEDs by writing bits in the register V_IN_OUT.

191	hd.1	R/W	Enable Multiset Instrument Control via serial
-----	------	-----	---

Table for multiset/virtual instrument			0
	Enable Multiset	Enable Virtual Instrument	
0			
1	X		
2		X	
3	X	X	

+16 For Heat/Cool control Ctr only: CT connected to cool output

224	S.In	R/W	Control Inputs from Serial
-----	------	-----	----------------------------

0 ... 255								0
Inputs	InTA	In.2	-	In.1	AL4	AL3	AL2	AL1
Bit	7	6	5	4	3	2	1	0

225	S.Ou	R/W	Control Outputs from Serial
-----	------	-----	-----------------------------

0 ... 1023										0
Outputs	Out10	Out9	Out8	Out7	Out6	Out5	Out4	Out3	Out2	Out1
Bit	9	8	7	6	5	4	3	2	1	0

628	SL.1	R/W	Control LEDs and digital inputs from serial
-----	------	-----	---

0 ... 1023										0
Bit	Inputs					LED				
	D2	D1	O4	O3	O2	O1	D2	D1	ER	RN
Bit	9	8	7	6	5	4	3	2	1	0

Table of virtual register addresses

Parameter	Bit	Resource Enabled	Address of Image Register	Format	Name of Register
S.In	0	Alarm setpoint AL1	341	word	AL1_RAM
	1	Alarm setpoint AL2	342	word	AL2_RAM
	2	Alarm setpoint AL3	343	word	AL3_RAM
	3	Alarm setpoint AL4	321	word	AL4_RAM
	4	Input In.1	347	word	VALUE_F
	6	Input In.2	348	word	VALAUX_F
	7	Input In.TA	685	word	VALTA_F
S.Ou	0	Output OUT 1	344	word, bit 0	V_IN_OUT
	1	Output OUT 2	344	word, bit 1	V_IN_OUT
	2	Output OUT 3	344	word, bit 2	V_IN_OUT
	3	Output OUT 4	344	word, bit 3	V_IN_OUT
	4	Output OUT 5 (relays)	344	word, bit 4	V_IN_OUT
	4	Output OUT 5 (continuous)	639	word	SERIAL_OUT5C*
	5	Output OUT 6 (relays)	344	word, bit 5	V_IN_OUT
	5	Output OUT 6 (continuous)	640	word	SERIAL_OUT6C*
	6	Output OUT 7 (relays)	344	word, bit 6	V_IN_OUT
	6	Output OUT 7 (continuous)	641	word	SERIAL_OUT7C*
	7	Output OUT 8 (relays)	344	word, bit 7	V_IN_OUT
	7	Output OUT 8 (continuous)	642	word	SERIAL_OUT8C*
	8	Output OUT 9	344	word, bit 8	V_IN_OUT
	9	Output OUT 10	344	word, bit 9	V_IN_OUT
S.LI	0	Led RN	351	word, bit 0	V_X_LEDS
	1	Led ER	351	word, bit 1	V_X_LEDS
	2	Led D1	351	word, bit 2	V_X_LEDS
	3	Led D2	351	word, bit 3	V_X_LEDS
	4	Led O1	351	word, bit 4	V_X_LEDS
	5	Led O2	351	word, bit 5	V_X_LEDS
	6	Led O3	351	word, bit 6	V_X_LEDS
	7	Led O4	351	word, bit 7	V_X_LEDS
	8	Input D1	344	word, bit 10	V_IN_OUT
	9	Input D2	344	word, bit 11	V_IN_OUT

* the value to be set is in the range 0...1000 if the corresponding rL.x is configured "0" or in the range 0...-1000 if the corresponding rL.x is configured "1".

Hardware and Software Information

The following data registers can be used to identify the controller HW/SW and check its operation.

122	uPd	R	Software version code
85	Err	R	Self-diagnosis error code for auxiliary input
606	Er2	R	Self-diagnosis error code for auxiliary input

190	[hd	R	Hardware configuration codes
-----	-----	---	------------------------------

At value SV on the C4-OP display, the figures indicate the value of bits as follows:

- THOUSANDS and HUNDREDS (Power C4-IR) correspond to bits 7 to 9
- TENS (COOL outputs) correspond to bits 1 to 4

Table of main input errors	
0	No Error
1	Lo (Process variable value < Lo.S)
2	Hi (Process variable value > Hi.S)
3	ERR (third wire interrupted for PT100 or input values below minimum limits (ex. for TC with connection error))
4	SBR (Probe interrupted or input values beyond maximum limits)

Table of hardware configuration codes		
Bit	Correspondence	Value Indicated by C4-OP(*)
0	= 1 OUTPUT COOL absent	0
1	= 1 OUTPUT COOL relay	r
2	= 1 OUTPUT COOL logic	d
3	= 1 OUTPUT COOL continuous 0...20mA / 0...10V	t
4	= 1 OUTPUT COOL triac 250Vac 1A	c
5	-	
6	= 1 C4 absent (C4XTERMO4 present)	te
7	= 1 C4 30 kW	30
8	= 1 C4 60 kW	60
9	= 1 C4 80 kW	80
10	= 1 C4 without TA	0
11	= 1 C4 with 1 TA	1
12	= 1 C4 with 4TA	4
13	= 1 C4XTERMO4 without TA	0
14	= 1 C4XTERMO4 with 4TA	4

508	C _{hd} I	R	Self-Diagnosis error code for auxiliary input
-----	-------------------	---	---

In correspondence to the SV value on the C4-OP display, the digits indicate bit values as follows:

- TENS (auxiliary inputs) correspond to bits 0 to 1
- ONES (fieldbus interface) correspond to bits 6 to 15

Table of auxiliary input errors		
Bit	Correspondence	Value Indicated by C4-OP(*)
0	= 1 INPUT AUX absent	0
1	= 1 INPUT AUX TC / 60mV	1
2	-	
3	= 1 FIELDBUS ETH4 (Profinet)	
4	= 1 FIELDBUS ETH5	
5	= 1 FIELDBUS ETH6	
6	= 1 FIELDBUS absent	O
7	= 1 FIELDBUS MODBUS	m
8	= 1 FIELDBUS PROFIBUS	P
9	= 1 FIELDBUS CANOPEN	C
10	= 1 FIELDBUS DEVICENET	D
11	= 1 FIELDBUS ETHERNET	E
12	= 1 FIELDBUS EUROMAP66	C
13	= 1 FIELDBUS ETH3	3
14	= 1 FIELDBUS ETH2 (ETHERCAT)	2

693 697	UPdF	R	Fieldbus software version
695	C _{od} F	R	Fieldbus node
696	b _{AUF}	R	Fieldbus baudrate

Profibus		Canopen		DeviceNet	
bAu.F	baudrate	bAu.F	baudrate	bAu.F	baudrate
0	12.00 Mbit/s	0	1000 Kbit/s	0	125 Kbit/s
1	6.00 Mbit/s	1	800 Kbit/s	1	250 Kbit/s
2	3.00 Mbit/s	2	500 Kbit/s	2	500 Kbit/s
3	1.50 Mbit/s	3	250 Kbit/s		
4	500.00 Kbit/s	4	125 Kbit/s		
5	187.50 Kbit/s	5	100 Kbit/s		
6	93.75 Kbit/s	6	50 Kbit/s		
7	45.45 Kbit/s	7	20 Kbit/s		
8	19.20 Kbit/s	8	10 Kbit/s		
9	9.60 Kbit/s				

Ethernet	
bAu.F	baudrate
0	100 Mbit/s
1	10 Mbit/s

346		R	Jumper State
-----	--	---	--------------

Table of Jumper State	
Bit	
0	Jumper State S1
1	Jumper State S2
2	Jumper State S7-1: Function Modes
3	Jumper State S7-2: Function Modes
4	Jumper State S7-3: Function Modes
5	Jumper State S7-4
6	Jumper State S7-5: 60Hz
7	Jumper State S7-6: CFG Forced
8	Jumper State S7-7: Simulation 4 C4

S7-1	S7-2	S7-3	FUNCTION MODES
0	0	0	4 Single Phase
1	0	0	3-Phase Star + 1 Single Phase
0	1	0	3-Phase Delta + 1 Single Phase
1	1	0	3-Phase 2 Leg Star
0	0	1	3-Phase 2 Leg Delta

120		R	Manufacturer - Trademark
121		R	Device ID

Constructors Name		5000
Product ID		198

197	LdSt	R/W	RN LED Status Function
-----	------	-----	------------------------

Table of RN LED Functions	
Value	Function
0	RUN
1	MAN/AUTO Controller
2	LOC/REM
3	HOLD
4	Selftuning ON
5	Autotuning ON
6	Repeat Digital Input D1
7	Serial 1 Dialog
8	State of OUT 2 Zone 1
9	Softstart Running
10	Indication of SP1...SP2 (SP1 with pilot input inactive and LED Off)
11	Repeat Digital Input D2
12	Input in Error (LO, HI, ERR, SBR)
13	Serial 2 Dialog
+ 16	LED Flashing if Active (Code 8 Excluded)

619	Ld2	R/W	ER LED status function		12																														
620	Ld3	R/W	Function of LED DI1		6																														
621	Ld4	R/W	Function of LED DI2		11																														
622	Ld5	R/W	Function of LED O1	<table border="1"> <thead> <tr> <th colspan="2">Table of OUT LED functions</th> <th></th> </tr> </thead> <tbody> <tr> <td>0</td> <td>Disabled</td> <td></td> </tr> <tr> <td>1</td> <td>Repetition of state OUT 1</td> <td rowspan="2">2</td> </tr> <tr> <td>2</td> <td>Repetition of state OUT 2</td> </tr> <tr> <td>3</td> <td>Repetition of state OUT 3</td> <td rowspan="3">3</td> </tr> <tr> <td>4</td> <td>Repetition of state OUT 4</td> </tr> <tr> <td>5</td> <td>Repetition of state OUT 5</td> </tr> <tr> <td>6</td> <td>Repetition of state OUT 6</td> <td rowspan="4">4</td> </tr> <tr> <td>7</td> <td>Repetition of state OUT 7</td> </tr> <tr> <td>8</td> <td>Repetition of state OUT 8</td> </tr> <tr> <td>9</td> <td>Repetition of state OUT 9</td> </tr> <tr> <td>10</td> <td>Repetition of state OUT 10 + 16 LED flashing if active</td> <td></td> </tr> </tbody> </table>	Table of OUT LED functions			0	Disabled		1	Repetition of state OUT 1	2	2	Repetition of state OUT 2	3	Repetition of state OUT 3	3	4	Repetition of state OUT 4	5	Repetition of state OUT 5	6	Repetition of state OUT 6	4	7	Repetition of state OUT 7	8	Repetition of state OUT 8	9	Repetition of state OUT 9	10	Repetition of state OUT 10 + 16 LED flashing if active		1
Table of OUT LED functions																																			
0	Disabled																																		
1	Repetition of state OUT 1	2																																	
2	Repetition of state OUT 2																																		
3	Repetition of state OUT 3	3																																	
4	Repetition of state OUT 4																																		
5	Repetition of state OUT 5																																		
6	Repetition of state OUT 6	4																																	
7	Repetition of state OUT 7																																		
8	Repetition of state OUT 8																																		
9	Repetition of state OUT 9																																		
10	Repetition of state OUT 10 + 16 LED flashing if active																																		
623	Ld6	R/W	Function of LED O2		2																														
624	Ld7	R/W	Function of LED O3		3																														
625	Ld8	R/W	Function of LED O4		4																														

EXCEPTIONS:

- If diagnostics has been activated (parameters Hb.F and hd.2) and an alarm is active, the red ER error LED and the yellow OX output LED for the zone with the alarm will flash in sync.
- In case of an OVER_HEAT (STATUS_INSTRUMENT 4 bit1) alarm, the red ER error LED will flash.

305		R/W	Current instrument state (STATUS_W)	Table of instrument settings	
698		R	Instrument state saved in eeprom (STATUS_W_EEP)	bit	
				0	-
				1	Select SP1/SP2
				2	Start/Stop Selftuning
				3	Select ON/OFF
				4	Select AUTO/MAN
				5	Start/Stop Autotuning
				6	Select LOC/REM

467	R	Instrument state	0 ... 65535	Table of instrument state
			bit	
			0	AL.1 or AL.2 or AL.3 or AL.4 or ALHB.TA1 or ALHB.TA2 or ALHB.TA3 or Power Fault
			1	Input Lo
			2	Input Hi
			3	Input Err
			4	Input Sbr
			5	heat
			6	cool
			7	LBA
			8	AL.1
			9	AL.2
			10	AL.3
			11	AL.4
			12	ALHB or Power Fault
			13	ON/OFF
			14	AUTO/MAN
			15	LOC/REM

469	R	Instrument state 1	0 ... 65535	Table of Instrument state 1
			bit	
			0	AL.1 or AL.2 or AL.3 or AL.4 or ALHB.TA1 or ALHB.TA2 or ALHB.TA3 or Power Fault
			1	AL. Lo
			2	AL. Hi
			3	AL. Err
			4	AL. Sbr
			7	AL.LBA
			8	AL.1
			9	AL.2
			10	AL.3
			11	AL.4
			12	ALHB.TA1
			13	ALHB.TA2
			14	ALHB.TA3
			15	Selftuning on

632	R	Instrument state 2	0 ... 65535	Table of Instrument state 2
			bit	
			0	AL.1
			1	AL.2
			2	AL.3
			3	AL.4
			4	AL.HB1
			5	AL.HB2
			6	AL.HB3
			7	AL.Lo
			8	AL.Hi
			9	AL.Err
			10	AL.Sbr
			11	AL.LBA
			12	AL.Power

633	R	Instrument state 3	0 ... 65535	Table of Instrument state 3
			bit	
			0	AL.SCR open 1
			1	AL.SCR open 2
			2	AL.SCR open 3
			3	AL.SCR short 1
			4	AL.SCR short 2
			5	AL.SCR short 3
			6	No voltage 1
			7	No voltage 2
			8	No Voltage 3
			9	No current 1
			10	No current 2
			11	No current 3

634	R	Instrument state 4	0 ... 65535	Table of Instrument state 4
			bit	
			0	Power_fail
			1	Over_heat

Instrument Configuration Sheet

Programmable Parameters

Definition of Parameter				Note	Assigned Value
-------------------------	--	--	--	------	----------------

Installation of Modbus Serial Network

46	CoD	R	Instrument identification code		
45	bAu	R/W	Select Baudrate - Serial 1		
626	bAu2	R/W	Select Baudrate - Serial 2		
47	PAR	R/W	Select Parity - Serial 1		
627	PAR2	R/W	Select Parity - Serial 2		

Main Input

400	tYP	R/W	Probe, signal, enable, custom linearization and main input scale		
403	dPS	R/W	Decimal point position for input scale		
401	LoS	R/W	Min. scale limit for main input		
402	HiS	R/W	Max. scale limit for main input		
519 23	oFS	R/W	Main input offset correction		
0 470	PV	R/W	Read of process variable (PV) engineering value		
85	Err	R	Self-diagnosis error code for main input		
24	FLt	R/W	low pass digital filter for input signal		
179	FLd	R/W	Digital filter on oscillations of input signal		
86	5.00	R/W	Engineering value attributed to Point 0 (min. value of input scale)		
87	5.01	R/W	Engineering value attributed to Point 1		
118	5.32	R/W	Engineering value attributed to Point 32 (max. value of input scale)		
293	5.33	R/W	Engineering value attributed to minimum value of the input scale		
294	5.34	R/W	Engineering value attributed to maximum value of the input scale.		
295	5.35	R/W	Engineering value of input signal corresponding to temp. of 50°C.		

CT Auxiliary Input

405	HtA1	R/W	Maximum scale limit of current transformer CT input (phase 1)		
413	HtA2	R/W	Maximum scale limit of current transformer CT input (phase 2)		
414	HtA3	R/W	Maximum scale limit of current transformer CT input (phase 3)		
220	oTA1	R/W	Offset correction for current transformer CT input (phase 1)		
415	oTA2	R/W	Offset correction for current transformer CT input (phase 2)		
416	oTA3	R/W	Offset correction for current transformer CT input (phase 3)		
227 473-139	ItA1	R	Instantaneous value of CT input (phase 1)		
490	ItA2	R	Instantaneous value of CT input (phase 1)		
491	ItA3	R	Instantaneous value of CT input (phase 3)		
468	I1on	R	Value of CT input with active output (phase 1)		
498	I2on	R	Value of CT input with active output (phase 2)		
499	I3on	R	Value of CT input with active output (phase 3)		
219	FtA	R/W	Digital filter for CT input (phases 1, 2 and 3)		
661	dGt	R/W	Sampling interval for CT input		

Voltage Value on Load (Voltmeter)

410	HtU1	R/W	Maximum scale limit of voltage transformer VT input (phase 1)		
417	HtU2	R/W	Maximum scale limit of voltage transformer VT input (phase 2)		
418	HtU3	R/W	Maximum scale limit of voltage transformer VT input (phase 3)		
411	oTU1	R/W	Offset correction of TV input (phase 1)		
419	oTU2	R/W	Offset correction of TV input (phase 2)		
420	oTU3	R/W	Offset correction of TV input (phase 3)		
232 485	tU1	R	Value of voltmeter input (phase 1)		
492	tU2	R	Value of voltmeter input (phase 2)		
493	tU3	R	Value of voltmeter input (phase 3)		
412	FtTU	R	Digital filter for TV auxiliary input (phase 1, 2, 3)		

Auxiliary Analog Input (LIN/TC)

194	R12	R/W	Select type of auxiliary input sensor		
181	tP2	R/W	Definition of auxiliary analog input function		
677	dP2	R/W	Decimal point position for auxiliary input scale		
404	L52	R/W	Minimum limit auxiliary input scale		
603	H52	R/W	Maximum limit auxiliary input scale		
605	oF52	R/W	Offset correction for auxiliary input		
602	In2	R	Value of auxiliary input		
606	E_r2	R	Self-diagnosis error code of auxiliary input		
604	FLL2	R/W	Digital filter for auxiliary input		

Digital Inputs

140	d 1G	R/W	Function of digital input		
618	d 1G	R/W	Function of digital input 2		
317		R	State of digital inputs INPUT DIG		
68 bit	State of Digital Input 1	R	OFF = Digital input 1 off ON = Digital input 1 on		
92 bit	State of Digital Input 2	R	OFF = Digital input 2 off ON = Digital input 2 on		

Generic Alarms AL1, AL2, AL3 and AL4

215	R1r	R/W	Select reference variable alarm 1		
216	R2r	R/W	Select reference variable alarm 2		
217	R3r	R/W	Select reference variable alarm 3		
218	R4r	R/W	Select reference variable alarm 4		
12 475-177	AL1	R/W	Setpoint alarm 1 (scale points)		
13 476-178	AL2	R/W	Setpoint alarm 2 (scale points)		
14 52-479	AL3	R/W	Setpoint alarm 3 (scale points)		
58 480	AL4	R/W	Setpoint alarm 4 (scale points)		
27 187	HY1	R/W	Hysteresis for alarm 1		
30 188	HY2	R/W	Hysteresis for alarm 2		
53 189	HY3	R/W	Hysteresis for alarm 3		
59	HY4	R/W	Hysteresis for alarm 4		
406	R1t	R/W	Alarm type 1		
407	R2t	R/W	Alarm type 2		
408 54	R3t	R/W	Alarm type 3		
409	R4t	R/W	Alarm type 4		
25 20-28-142	LoL	R/W	Lowest settable limit SP, SP remote and absolute alarms		
46 bit	AL1 direct/inverse	R			

47 bit	AL1 absolute/relative	R			
48 bit	AL1 normal/symmetrical	R			
49 bit	AL1 disabled at switch on	R			
50 bit	AL1 with memory	R			
54 bit	AL2 direct/inverse	R			
55 bit	AL2 absolute/relative	R			
56 bit	AL2 normal/symmetrical	R			
57 bit	AL2 disabled at switch on	R			
58 bit	AL2 with memory	R			
36 bit	AL3 direct/inverse	R			
37 bit	AL3 absolute/relative	R			
38 bit	AL3 normal/symmetrical	R			
39 bit	AL3 disabled at switch on	R			
40 bit	AL3 with memory	R			
70 bit	AL4 direct/inverse	R			
71 bit	AL4 absolute/relative	R			
72 bit	AL4 normal/symmetrical	R			
73 bit	AL4 disabled at switch on	R			
74 bit	AL4 with memory	R			
26 21-29-143	HIL	R/W	Highest settable limit SP, SP remote and absolute alarms		
195	AL _n	R/W	Select number of enabled alarms		
140	dIG	R/W	Digital input function		
618	dIG2	R/W	Digital input function 2		

79 bit	Reset Alarm Latch	R/W	OFF = - ON = Reset alarm latch
4 bit	State of Alarm 1	R	OFF = Alarm off ON = Alarm on
5 bit	State of Alarm 2	R	OFF = Alarm off ON = Alarm on
62 bit	State of Alarm 3	R	OFF = Alarm off ON = Alarm on
69 bit	State of Alarm 4	R	OFF = Alarm off ON = Alarm on
318		R	State of alarm ALSTATE IRQ

LBA Alarm (Loop Break Alarm)

195	ALn	R/W	Select number of enabled alarms
44	Lbt	R/W	Delay time for LBA alarm activation
119	LbP	R/W	Limit of supplied power in presence of LBA alarm
81 bit	Reset LBA alarm	R	OFF = - ON = Reset alarm LBA
8 bit	State of LBA alarm	R	OFF = LBA off ON = LBA alarm on

Heater Break Alarm

195	ALn	R/W	Select number of enabled alarms
57	HbF	R/W	HB alarm function
56	Hbt	R/W	Delay time for HB alarm activation
55	AHb1	R/W	HB alarm setpoint (ammeter input scale points - Phase 1)
502	AHb2	R/W	HB alarm setpoint (ammeter input scale points - Phase 2)
503	AHb3	R/W	HB alarm setpoint (ammeter input scale points - Phase 3)
26 bit	State of HB alarm or Power_fault	R	OFF = Alarm off ON = Alarm on
76 bit	State of HB Alarm phase 1	R	
77 bit	State of HB Alarm phase 2	R	with 3-phase load
78 bit	State of HB Alarm phase 3	R	with 3-phase load
504		R	States of alarm HB ALSTATE_HB (for 3-phase loads)

512		R	States of alarm ALSTATE (for single-phase loads)		
Alarm SBR - ERR (Probe in short or connection error)					
229	rEL	R/W	Fault action (in case of broken probe) Sbr, Err Only for main input		
228	FAP	R/W	Fault action power (supplied in condition of broken probe)		
85	Errr	R	Self-diagnosis error code for main input		
9 bit	State of Input in SBR	R	OFF = - ON = Input in SBR		

Power Fault ALARMS (SSR_SHORT, NO_VOLTAGE and NO_CURRENT)

660	hd2	R/W	Enable POWER_FAULT Alarms		
661	dUt	R/W	Refresh rate in TA (Only For C4 1TA)		
662	dUF	R/W	Filter in Time For NO_VOLTAGE, SSR_OPEN and NO_CURRENT alarms (Only For C4 1TA)		
663	dCP	R/W	Min acquisition power in TA and for NO_CURRENT (Only For C4 1TA)		
105 bit	Reset SSR_OPEN/SSR_SHORT,NO_VOLTAGE/NO_CURRENT Alarms	R/W			
93 bit	State of alarm SSR_OPEN phase 1	R			
94 bit	State of alarm SSR_OPEN phase 2	R			
95 bit	State of alarm SSR_OPEN phase 3	R			
96 bit	State of alarm SSR_SHORT phase 1	R			
97 bit	State of alarm SSR_SHORT phase 2	R			
98 bit	State of alarm SSR_SHORT phase 3	R			
99 bit	State of alarm NO_VOLTAGE phase 1	R			
100 bit	State of alarm NO_VOLTAGE phase 2	R			
101 bit	State of alarm NO_VOLTAGE phase 3	R			
102 bit	State of alarm NO_CURRENT phase 1	R			
103 bit	State of alarm NO_CURRENT phase 2	R			

104 bit	State of alarm NO_CURRENT phase 3	R	
---------	--------------------------------------	---	--

Alarm due to overload

655		R	INPTC
675		R	INPTC_DER

Outputs

160	rL1	R/W	Allocation of reference signal		
163	rL2	R/W	Allocation of reference signal		
166	rL3	R/W	Allocation of reference signal		
170	rL4	R/W	Allocation of reference signal		
171	rL5	R/W	Allocation of reference signal		
172	rL6	R/W	Allocation of reference signal		
308 319		R	State outputs rL.x MASKOUT		
12 bit	STATE rL.1	R	OFF = Output off ON = Output on		
13 bit	STATE rL.2	R	OFF = Output off ON = Output on		
14 bit	STATE rL.3	R	OFF = Output off ON = Output on		
15 bit	STATE rL.4	R	OFF = Output off ON = Output on		
16 bit	STATE rL.5	R	OFF = Output off ON = Output on		
17 bit	STATE rL.6	R	OFF = Output off ON = Output on		
607	out1	R/W	Allocation of physical output OUT 1		
608	out2	R/W	Allocation of physical output OUT 2		
609	out3	R/W	Allocation of physical output OUT 3		
610	out4	R/W	Allocation of physical output OUT 4		
611	out5	R/W	Allocation of physical output OUT 5		
612	out6	R/W	Allocation of physical output OUT 6		
613	out7	R/W	Allocation of physical output OUT 7		

614	OUT8	R/W	Allocation of physical output OUT 8		
615	OUT9	R/W	Allocation of physical output OUT 9		
616	OUT10	R/W	Allocation of physical output OUT 10		
82 bit	State of output OUT1	R	OFF = Uscita disattiva ON = Uscita attiva		
83 bit	State of output OUT2	R			
84 bit	State of output OUT3	R			
85 bit	State of output OUT4	R			
86 bit	State of output OUT5	R			
87 bit	State of output OUT6	R			
88 bit	State of output OUT7	R			
89 bit	State of output OUT8	R			
90 bit	State of output OUT9	R			
91 bit	State of output OUT10	R			

Setpoint Settings

138 16-472	SP	R/W	Local setpoint		
181	LP2	R/W	Auxiliary analog input function		
18 136-249	LP2	R/W	Remote setpoint (SET Gradient for manual power correction)		
25 20-28-142	LoL	R/W	Lowest settable limit SP, SP remote and absolute alarms		
26 21-29-143	HiL	R/W	Highest settable limit SP, SP remote and absolute alarms		
10 bit	LOCAL / REMOTE	R	OFF = Enable local setpoint ON = Enable remote setpoint		
305		R/W	Instrument state (STATUS_W)		
1 137-481	SPA	R/W	Active Setpoint		

4		R	Deviation (SPA - PV)
---	--	---	----------------------

Setpoint Control

234 22	OSP	R/W	Set Gradient
259	OS2	R/W	Set Gradient for SP2
265	Hot	R/W	Select specialized control functions
191	hd1	R/W	Enable multiset instrument control via serial
230 482	SP1	R/W	Setpoint 1
231 483	SP2	R/W	Setpoint 2
140	dIG1	R/W	Digital input function
618	dIG2	R/W	Digital input function 2
75 bit	SELECT SP1 / SP2	R	OFF = Select SP1 ON = Select SP2
305		R/W	Instrument state

PID Heat/ Cool Control

617	SPU	R/W	Enable zone process variable
180	Ctrl	R/W	Control Type
5 148-149	SPU	R/W	Enable zone process variable
7 150	ht	R/W	Integral heating time
8 151	hdt	R/W	Derivative heating time
6	cPb	R/W	Proportional band for cooling or hysteresis ON/OFF
76	ct	R/W	Integral cooling time
77	cdt	R/W	Derivative cooling time
513	CNE	R/W	Select cooling fluid
152 9	CT1	R/W	Cycle time OUT 1 (Heat)
159	CT2	R	Cycle time OUT 2 (Cool)

2 132-471	QvP	R	Value control outputs (+Heat / -Cool)		
39 484	cSP	R/W	Cooling setpoint relative to heating setpoint		
78	rSt	R/W	Manual reset (value added to PID input)		
516	P-rS	R/W	Reset power (value added directly to PID output)		
79	A-rS	R/W	Antireset (limits integral PID action)		
80	FFd	R/W	Feedforward (value added to PID output after processing)		
42 146	hPH	R/W	Maximum limit heating power		
254	hPL	R/W	Min. limit heating power (not avail- able for double action heat/cool)		
43	cPH	R/W	Maximum limit cooling power		
255	cPL	R/W	Min. limit cooling power (not avail- able for double action heat/cool)		
765	PPEr	R/W	Percentage of output power		
766	PoFS	R/W	Offset output power		

Automatic/Manual Control

2 132-471	QvP	R/W	Value control outputs (+Heat / -Cool)		
140	d I0	R/W	Digital input function		
618	d I02	R/W	Digital input function 2		
1 bit	AUTO/MAN	R/W	OFF = Automatic ON = Manual		
305		R/W	Instrument state		

Hold Function

140	d I0	R/W	Digital input function		
618	d I02	R/W	Digital input function 2		
64 bit	HOLD	R/W	OFF = hold off ON = hold on		

Manual Power Correction

505	r IF	R/W	Line voltage		
-----	------	-----	--------------	--	--

506	COF	R/W	Manual power correction based on line voltage		
18 136-249	SPR	R/W	Remote setpoint (SET Gradient for power correction		

Autotuning

31	STU	R/W	Enable selftuning, autotuning, softstart		
140	DI1	R/W	Digital input function		
618	DI2	R/W	Digital input function 2		
29 bit	AUTOTUNING	R/W	OFF = Stop Autotuning ON = Start Autotuning		
28 bit	AUTOTUNING STATE	R/W	OFF = Autotuning in Stop ON = Autotuning in Start		
68 bit	DIGITAL INPUT STATE 1	R/W	OFF = Digital input 1 off ON = Digital input 1 on		
92 bit	DIGITAL INPUT STATE 2	R/W	OFF = Digital input 2 off ON = Digital input 2 on		
296		R/W	Enable autotuning and selftuning state (FLG_PID)		
305		R/W	Instrument state		

Selftuning

31	STU	R/W	Enable selftuning, autotuning, softstart		
140	DI1	R/W	Digital input function		
618	DI2	R/W	Digital input function 2		
3 bit	SELFTUNING	R/W	OFF = Stop Selftuning ON = Start selftuning		
0 bit	SELFTUNING STATE	R	OFF = Selftuning in Stop ON = Selftuning in Start		
68 bit	DIGITAL INPUT STATE 1	R/W	OFF = Digital input 1 off ON = Digital input 1 on		

92 bit	DIGITAL INPUT STATE 2	R/W	OFF = Digital input 2 off ON = Digital input 2 on		
305		R/W	Instrument state		

Softstart

31	Stu	R/W	Enable selftuning, autotuning, softstart		
263	SPS	R/W	Softstart Setpoint		
264	SOP	R/W	Softstart power		
147	SOF	R/W	Softstart time		
629	PSOF	R/W	Minimum non-conduction time to reactivate phase softstart ramp		
630	PSH1	R/W	Maximum phase of phase softstart ramp		
63 bit	SOFTSTART STATE	R/W	OFF = Softstart in Stop ON = Softstart in Start		

Software Shutdown

140	dIG	R/W	Digital input function		
618	dIG2	R/W	Digital input function 2		
11 bit	SOFTWARE ON/OFF	R/W	OFF = On ON = Off		
68 bit	DIGITAL INPUT STATE 1	R/W	OFF = Digital input 1 off ON = Digital input 1 on		
92 bit	DIGITAL INPUT STATE 2	R/W	OFF = Digital input 2 off ON = Digital input 2 on		
305		R/W	Instrument state		

Fault Action Power

265	Hot	R/W	Select specialized control functions		
228	FAP	R/W	Fault action power (supplied in conditions of broken probe)		
26 bit	STATE OF HB ALARM OR POWER_FAULT	R/W	OFF = Alarm off ON = Alarm on		
80 bit	State of power alarm	R/W	OFF = Alarm off ON = Alarm on		

Power Alarm

261	bSt	R/W	Stability band (power alarm function)		
-----	-----	-----	---------------------------------------	--	--

262	bPF	R/W	Power alarm band (power alarm function)		
260	PFE	R/W	Power alarm delay times		
160	rL1	R/W	Allocation of reference signal		
163	rL2	R/W	Allocation of reference signal		
166	rL3	R/W	Allocation of reference signal - Output OR		
170	rL4	R/W	Allocation of reference signal - Output AND		
171	rL5	R/W	Allocation of reference signal - Output OR		
172	rL6	R/W	Allocation of reference signal - Output AND		

Preheating Softstart

31	Stu	R/W	Enable selftuning, autotuning, softstart		
263	SPS	R/W	Softstart Setpoint		
264	SoP	R/W	Softstart power		
147	SoF	R/W	Softstart time		
63 bit	SOFTSTART STATE	R/W	OFF = Softstart in Stop ON = Softstart in Start		

Heating Output (Fast Cycle)

160	rL1	R/W	Allocation of reference signal		
163	rL2	R/W	Allocation of reference signal		

Heuristic Power Control

680	hd3	R/W	Enable heuristic power control		
681	IHEU	R/W	Maximum current for heuristic power control		

Heterogeneous Power Control

682	hd4	R/W	Enable heterogeneous power control		
683	HEt	R/W	Maximum current for heterogeneous power control		

Virtual Instrument Control

191	hd1	R/W	Enable multiset instrument control via serial		
224	5In	R/W	Control Inputs from Serial		
225	5Ou	R/W	Control Outputs from Serial		
628	SL1	R/W	Control LEDs and digital inputs from serial		

HW/SW Data

122	UPd	R	Software version code		
85	Err	R	Self-diagnosis error code for main input		
606	Er2	R	Self-diagnosis error code for auxiliary input		
190	Chd	R	Hardware configuration codes		
508	Chd1	R	Self-diagnosis error code for auxiliary input		
693 697	UPdF	R	Fieldbus software version		
695	CodF	R	Fieldbus node		
696	bAUF	R	Fieldbus baudrate		
346		R	State of jumper		
120		R	Manufacturer - Trade Mark		
121		R	Device ID (C4)		
197	Ld5t	R/W	RN LED Status Function		
619	Ld2	R/W	ER LED status function		
620	Ld3	R/W	Function of LED DI1		
621	Ld4	R/W	Function of LED DI2		
622	Ld5	R/W	Function of LED O1		

623	Ld6	R/W	Function of LED O2		
624	Ld7	R/W	Function of LED O3		
625	Ld8	R/W	Function of LED O4		
305		R/W	Instrument state		
467		R	Instrument state		
469		R	Instrument state 1		
632		R	Instrument state 2		
633		R	Instrument state 3		
634		R	Instrument state 4		

Limited Warranty:

Please refer to the Chromalox limited warranty applicable to this product at <http://www.chromalox.com/customer-service/policies/termsofsale.aspx>.

Chromalox, Inc.
1347 Heil Quaker Boulevard
Lavergne, TN 37086
(615) 793-3900
www.chromalox.com