

Installation & Operation Manual

ITC-FS 1 & 2 Circuit Heat Trace Controller for Fire Suppression Systems

IntelliTrace



 **CHROMALOX**
Advanced Thermal Technologies

PK543-2
0037-75525
March 2025

Table of Contents

<u>Section</u>	<u>Page</u>
Table of Contents	2
Safety Precautions	3
Introduction	4
Model Overview.....	5
Theory of Operation	6
Before Powering Up	6
Installation	7
Operating the ITC-FS	9
HMI (Human – Machine Interface).....	9
Main Window	9
Navigating the ITC-FS.....	10
The Keypad	11
Programming the ITC-FS	11
Security Levels	12
The Temperature Menu	12
The Current Menu	13
The Control Menu	13
The Soft Start Function	15
The Comms Menu (Communications).....	15
The System Menu	18
Current Sampling	20
Alarms	20
Dimensions.....	21
Default Settings.....	22
Specifications.....	24
Equipment Ratings.....	26
Field Wiring Considerations	26
Modbus Wiring Considerations.....	26
Customer Wiring.....	27
Modbus Serial Communications	31
Service Contact Information.....	35

Safety Precautions



Throughout the IntelliTRACE™ Setup Guide, these symbols will alert you to potential hazards. Safety precautions should always be followed to reduce the risk of fire, electrical shock, injury and even death to persons. Please read all instructions before operating your IntelliTRACE™ ITC-FS1 and ITC-FS2 Heat Trace Controller.



To avoid electrical shock or injury, always remove power before servicing a circuit. Personnel working with or near high voltages should be familiar with modern methods of resuscitation. Contact an area supervisor, registered electrician or safety personnel for more information.

⚠ WARNING

HIGH VOLTAGE is used in the operation of this equipment; DEATH ON CONTACT may result if personnel fail to observe safety precautions.

Learn the areas containing high-voltage connections when installing or operating this equipment.

Be careful not to contact high-voltage connections when installing or operating this equipment.

Before working inside the equipment, turn power off and ground all points of high potential before touching them.

Users should install adequate controls and safety devices with their electric heating equipment. Where the consequences of failure may be severe, back-up controls are essential. Although the safety of the installation is responsibility of the user, Chromalox will be glad to assist in making equipment recommendations.

A disconnect device and circuit breaker should be provided in the end installation. The installation and proximity for the disconnect device must satisfy the electrical Authority having jurisdiction for the installation, such as NEC.

Branch circuit protection should be set for 30 amps or lower.

⚠ WARNING

ELECTRIC SHOCK HAZARD. Any installation involving control equipment must be performed by a qualified person and must be effectively grounded in accordance with the National Electrical Code to eliminate shock hazard.

⚠ WARNING

Should the equipment be used in a manner not specified by Chromalox, the protection provided may be impaired.

Introduction

For nearly a century, customers have relied upon Chromalox for premiere quality and innovative solutions for industrial heating applications. Chromalox manufactures the world's largest and broadest line of electric heat and control products.

The **intelliTRACE™** family of heat tracing products continues to expand with its latest single or two circuit controllers the ITC-FS1 and ITC-FS2. These are a complete temperature control and system management solutions for electrical heat trace applications.

The **intelliTRACE™** ITC-FS1 and ITC-FS2 provides the user with an easy to navigate menu system, continuous critical parameter monitoring, application flexibility and equipment safety precautions.

The ITC-FS is an ideal solution for Freeze Protection of Fire Suppression Systems.

intelliTRACE™ ITC-FS Features:

- 1 & 2 Circuit Models
- 100 – 277 VAC, 50/60 Hz
- SSR Control, 30 Amps per Circuit
- PID, On/Off or Manual Control Modes
- Selectable Soft Start Feature
- ModBus Communications*
 - RTU/RS485 (& 422)
- Full Monitoring & Alarms
 - High / Low Temperature
 - High & Low Current
 - GFEP & Sensor Failure
- Programmable Duty Cycle On Sensor Failure
- Alarm Indication & Announcement
- Password Protected Security Levels
- NEMA 4X Fiberglass
- LED Indication for Power, Load & Alarm per Circuit
- Front Panel Capacitive Touch Switches
- Two Sensor Inputs / Circuit – One for Ambient control and one for pipe temp/alarms.
- 2 Circuit Ambient control from a single RTD sensor
- High Resolution TFT Display:
 - 2 Circuits displayed / screen (on 2 Circuit unit)
 - Displayed Parameters: Process Variable, Set Point Temperature, Control Mode, Soft Start status, Load demand, Alarm Status

Agency Approvals:

- UL, Freeze Protection on Fire Suppression Systems
- **To comply with the UL approval for Fire Sprinklers the power connection between the cable and the ITC-FS must be made with an RTBC-FS (PCN 514394)). The bulb of the RTBC-FS must be placed on one of the sprinkler sprig pipes nearest the sprig head. One RTBC-FS per ITC-FS circuit is required. Example: A 2 circuit ITC-FS must have 2 RTBC-FS's and use one for each circuit.**

Options:

- BACnet Communications (Optional via MBC (PCN 387401))

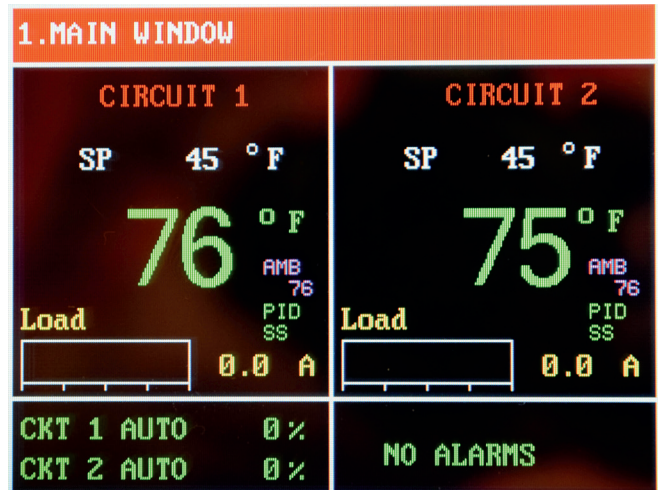

i **IMPORTANT:** To comply with NEC code, one of the following must apply.

1. Customer supplied 2 pole GFEP breaker in branch circuit breaker box upstream of the controller.

*Alarm outputs must be used to comply with the UL Fire Suppression Standard to send a supervisory signal. Modbus communications provide supplementary information to the user but alarm outputs must be used in conjunction for compliance to the UL Fire Suppression Standards.

Model Overview

The ITC-FS series IntelliTRACE Controller is designed for freeze protection of Fire Suppression Systems. The ITC-FS series controller will control 1 or 2 circuits and is a wall mounted device that operates at 100 to 277 VAC and offers the following standard design features: NEMA 4X FG enclosure, 3.5” High Resolution TFT Display with integral display heater, front panel capacitive touch switches & LED Indication of Power, Load & Alarm.

It also offers PID, ON/OFF or Manual SSR power control, is rated at 30A per circuit in a -40°F to 104°F Ambient, employs a Soft Start program and accepts up to 2 RTD sensors per circuit to provide Ambient sensing for control and line sensing for pipe temp/alarms.

The ITC-FS2 may also be used as a 2-channel ambi-

ent sensing controller using one RTD to control both circuits. An additional sensor per circuit must be used for pipe temp/alarms.

Other standard features include: Alarms (1xAC & 1xDC) for High & Low Current, GFEP (Ground Fault Equipment Protection), High & Low Temperature & Sensor Failure, ModBus RTU/RS485 & /RS422 Communications. Alarms are set up to be normally closed.

Options include:

BACnet Communications (Optional via MBC (PCN 387401)

Please see Table 1 below for applicable features & capabilities by Model type.

Table 1

Features / Capabilities	ITC1-FS	ITC2-FS
30 Amps/ Loop @ 100 to 277 Volts	X	X
Number of Circuits	1	2
SSR (Solid State Relay) Control	X	X
3.5” 320x240 RGB Full color graphic TFT module	X	X
10” x 8” x 6” NEMA 4X FG Enclosure	X	X
Soft Start Feature	X	X
PID, ON/OFF or Manual Control	X	X
RTU/RS485 & /RS422 ModBus Communications	X	X
Two RTD Sensors per Circuit	X	X
Temperature Monitoring and Alarms	X	X
GFEP Monitoring and Alarms	X	X
Current Load Monitoring and Alarms	X	X
Sensor Failure Monitoring and Alarms	X	X
Three Levels of Security	X	X
BACnet Communications (Optional via MBC (PCN 387401)	X	X

Theory of Operation

The detailed set up of the individual circuit parameters is explained throughout the various sections of this manual. This Theory of Operation overview is intended to give a quick summary of how it all works together.

- Parameter setpoints (High/Low Temperature, High/Low Current & GFEP), Control Modes (Auto or Manual) and operation modes under alarm conditions (GFEP limit violation & Sensor Loss) are entered for each circuit. Each circuit is designed to operate independently.
- Active loops are individually tested for 2 seconds every 2 minutes. During the test, a current load value is updated on the yellow bar located on the Main Window and a new GFEP current is automatically and continuously calculated.
- If the Ground Fault (GFEP) limit is surpassed and the alarm is triggered, the ITC-FS has four options of behavior:
 1. Alarm, non-latching – No change in output.
 2. Alarm and Trip, non-latching – Output goes to 0% (off) while in alarm state.
 3. Alarm, latching – No change in output.
- Alarm will be cleared when sensed GFEP is 5mA less than GFEP setpoint.

4. Alarm & trip, latching – Output goes to 0% (off) while in alarm state.

- Alarm condition may only be cleared with a manual reset of the alarm
- Similarly, should a failed sensor condition appear, the ITC-FS will go into alarm state and display a flashing sensor error. The ITC-FS will automatically be switched into Manual mode. The output % may be adjusted by the user within the **SYSTEM MENU** Parameter: “Failed Sensor Output 1 (or 2)”. See Temperature Sensing & Failed Sensor Output parameters in the System Menu definitions below.
- To limit inrush current on the overall system, a proprietary Soft Start algorithm is applied during system start-up. This will ONLY occur while the operation mode is set to AUTO. The Soft Start program will increment the output by 1% every 1 second until the desired temperature is reached or the output % achieves 100%. After the Soft Start program completes its cycle, the Auto Control Mode of the system will return to either PID or ON/OFF Control Mode, depending what was selected by the user. The Soft Start Program will not function if the control mode is set to Manual.

Before Powering Up

Chromalox takes great pride in knowing that we have provided to you a product of premium quality and workmanship. We have taken every precaution to ensure that your equipment arrives safe and secure.

However, vibration and temperature changes during shipping can cause some components to become loose. Additionally, throughout the life span of this product, other environmental and application conditions may have affected the mechanical and electrical continuity of several internal components. Therefore, for your safety and overall product performance, please take the time to familiarize yourself with the **MAINTENANCE, OPERATION, AND INSTALLATION INSTRUCTIONS** technical manual that was shipped with your control product.



Since it is not uncommon for electrical wiring and mechanical connections to become slightly loosened during shipment, we ask that you pay particular attention to section 4-5.3:

Wiring and Connections

Check wiring and connections as follows:

- a. Inspect wiring for wear, fraying, chipping, nicks, and evidence of overheating. Repair minor defects with a good grade of electrical tape, or replace if needed.
- b. Inspect for loose electrical and mechanical connections. Tighten or replace defective crimp-style lugs. Re-solder loose solder connections. Tighten or replace all loose or missing hardware.

These precautions must be adhered to when the product is received as well as before every season or on an annual basis, whichever is shortest.

Installation

⚠ CAUTION

The ITC-FS employs a SSR (Solid State Relay) as a means to switch the heating load power. Inherently, SSR's produce heat when operating. Heat is dissipated at the rear of the ITC-FS through a heat sink. By design, the ITC-FS must be mounted in a vertical orientation in order to allow the heat sink to properly dissipate the heat from the controller. See Figure 1.

The ITC-FS is shipped with a pair of stainless steel mounting brackets. These brackets were specifically designed to allow sufficient airflow in and around the heat sink. The air flow above or below this heat sink must in no way become restricted. See Figure 1.

To maintain UL compliance, the heat sink must be inspected every season to confirm that no debris or objects are in contact with the heat sink. All debris must be removed from the heat sink fins. High pressure blasts of clean, dry air or other means which will not damage the fins are to be used to dislodge all debris from the fins.



Figure 1

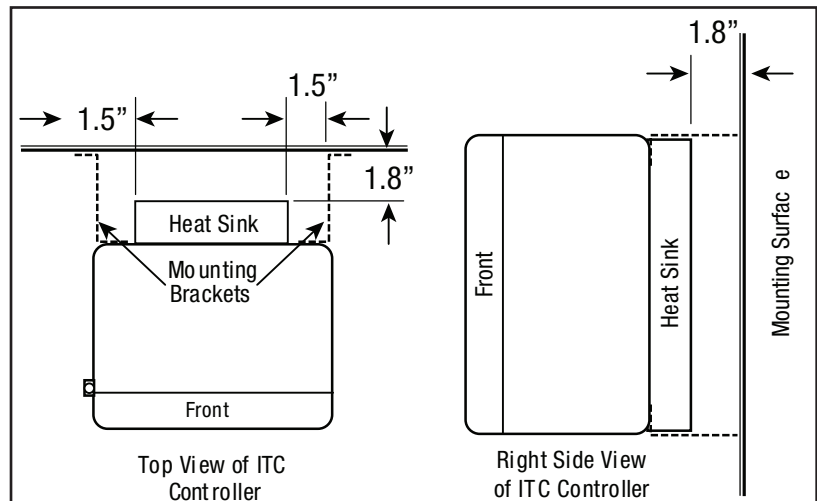

Figure 2

Should the owner decide not to use the provided brackets, mounting of the ITC-FS must incorporate all of the following dimensional safeguards (Refer to Figure 2):

1. Maintain a minimum of 1.5" (3.8 cm) of free air space on either side of the heat sink (K)
2. Maintain a minimum of 1.8" (4.6 cm) of free air space directly behind the heat sink (C)
3. Zero air flow restriction above and below the heat sink.
4. The mounting surface, customer mounting bracket and fasteners must be of suitable structural design to support four times the weight of the equipment.

⚠ WARNING

Violating any of the heat sink clearance dimensions or if the equipment is used or mounted in a manner not specified by Chromalox, the protection provided may be impaired. This could result in equipment damage, personal injury or both.

Mounting Surface Considerations

The preferred materials of the mounting surface include metals, concrete or wood products. If the ITC-FS is to be mounted outdoors, then the metals shall have corrosion resistant properties and the wood products shall be treated for outdoor use. If the mounting surface is plaster (drywall), it shall be of the following minimum construction: 1/2", +/-1/16" (10 mm, +/-2mm) in thickness and supported by nominal 2" x 4" (50mm x 100mm, +/-10 mm) studs that are on 16", +/- 1/2" (400mm, +/- 10mm) centers. See Dimensions section for wall mount layout and hole location. Mounting shall be performed by experienced professionals.

Fasteners

The fasteners shall be of 300 series (304 or 316) stainless steel and they shall be a #8 or #10 (or metric equivalent) bolt or screw configuration. If anchors are to be used, ensure that they match the fastener specification.

⚠ WARNING

Improper mounting may cause an unsafe condition resulting in equipment damage or failure which could cause personal injury.

Installation

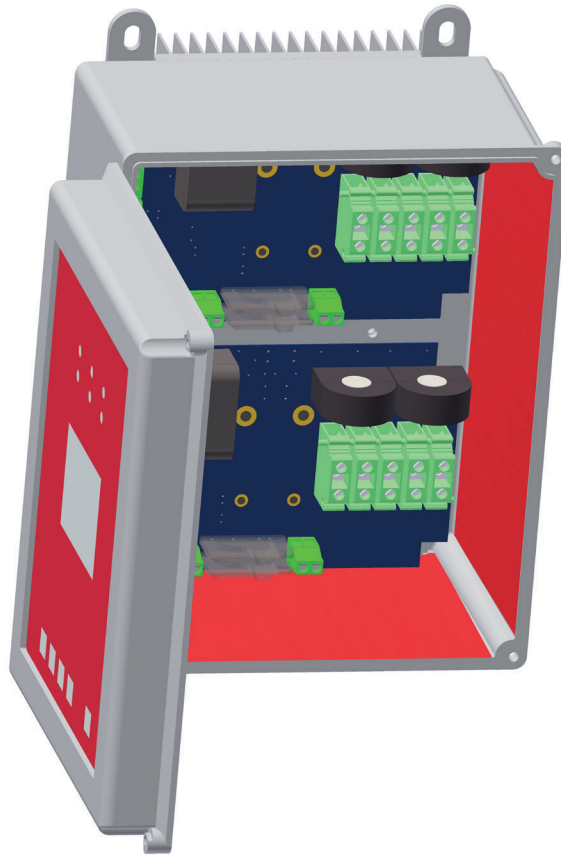

⚠ WARNING

The conduit hub must be connected to the conduit before connection to the enclosure is made.

Mounting Surface Considerations

Conduit Installation Conduit entries may be made in the red shaded area of the enclosure shown above. If possible conduit entries should be made on the bottom of the enclosure to reduce the possibility of water entry or leakage. Conduit entries must be drilled/ punched following the enclosure manufacturers' recommendations. Use fittings suitable for the enclosure type and install such that the completed installation remains waterproof. For nonmetallic enclosures, grounding hubs and conductors must be installed in accordance with Article 501-4(b) of the National Electrical Code and Part I of the Canadian Electrical Code.

Conduit Spacings

The maximum number of conduit entries on the bottom of the enclosure (shaded in red) is 3 and the maximum number of conduit entries on the side of the enclosure (shaded in red) is 3. Ensure 3/4" conduits have a 1-13/16" spacing from center to center and 1/2" conduits have a 1-9/16" spacing from center to center. Ensure 3/4" conduit fittings have a 1-13/16" spacing from nearest obstruction and a 1/2" conduit fitting has a 1-9/16" spacing from the nearest obstruction.

Operating the ITC-FS

HMI (Human – Machine Interface)

There are three areas on the front panel of the ITC-FS in which the User may visually receive information or provide input to the controller:

1. LED status indication for Power, Load & Alarm for each circuit
2. Hi Resolution TFT displays the parameter settings, alarm type, mode of operation, current load demand, program menu screen and menu selection items
3. Capacitive touch keypad



Main Window

In normal operating mode, the main window screen on the ITC-FS displays the circuit number, set point temperature, process temperature, current load demand, soft start status, mode of operation, output % and alarm type for each active circuit.

Below is the Main Window for a 2 Circuit ITC-FS.

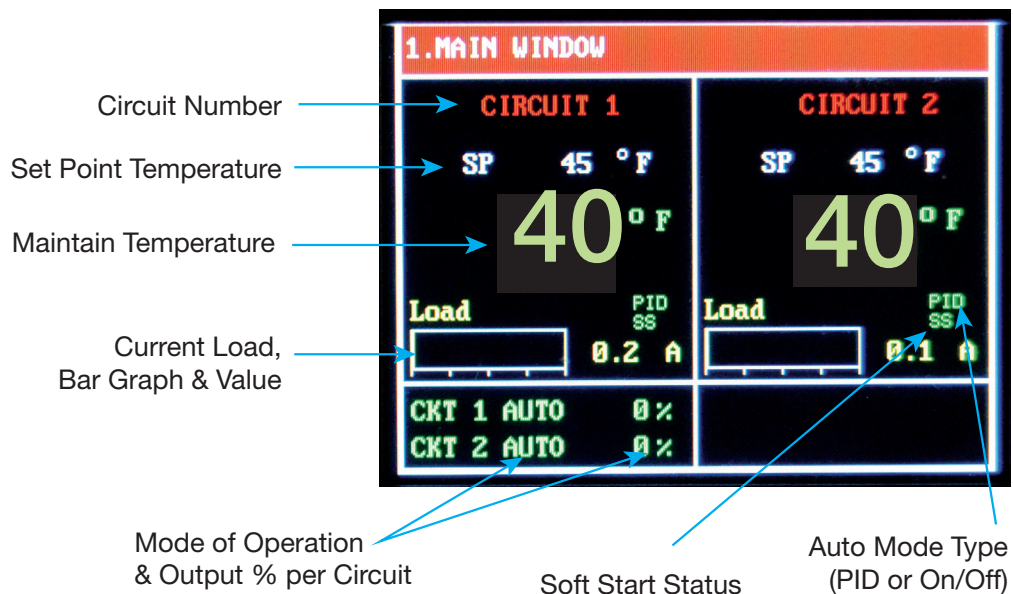

Navigating the ITC-FS

Visually, here is how one navigates through the ITC-FS Menus & Parameters:

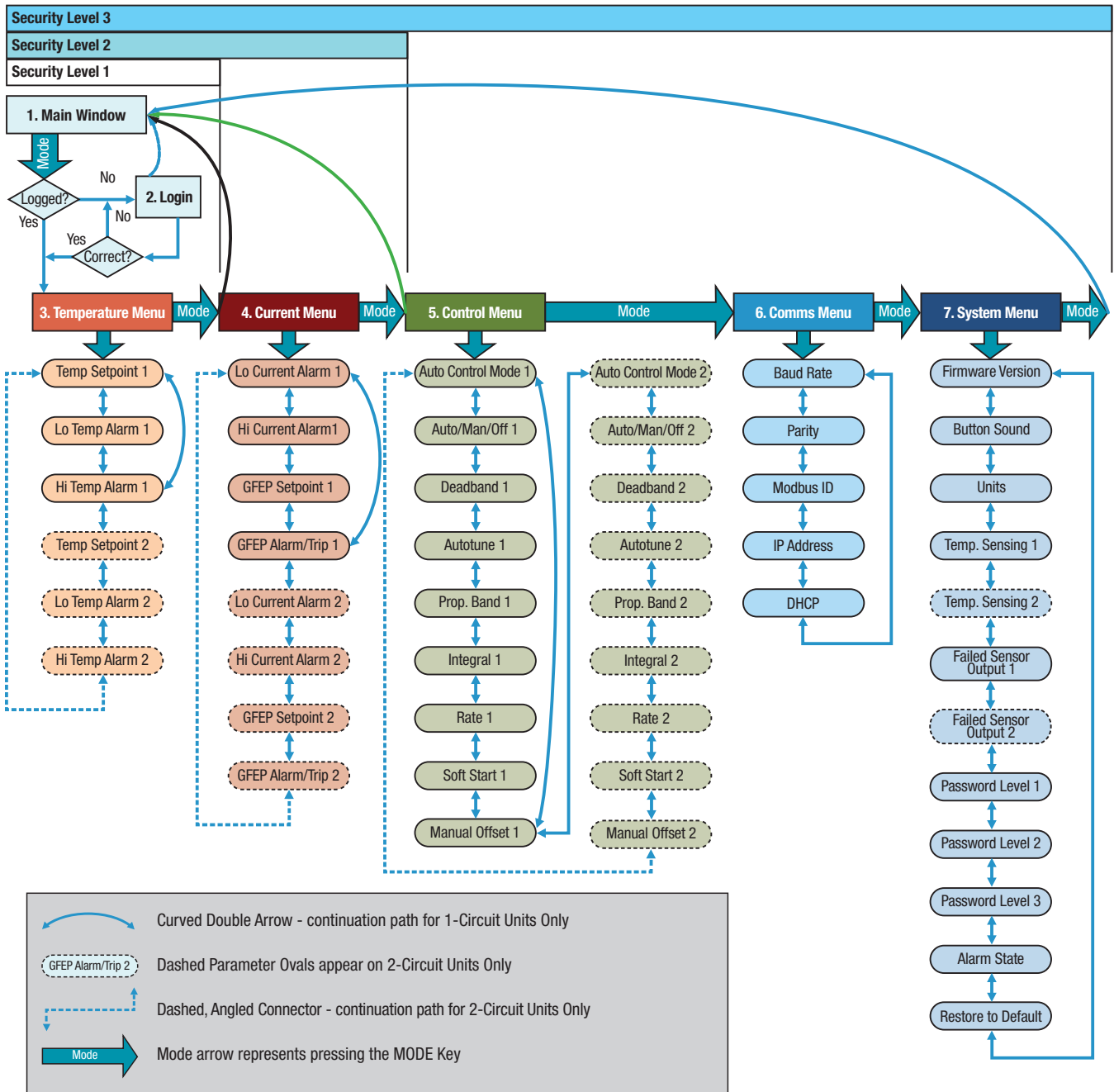

The horizontal security level bars, which are above the ITC-FS Menu & Parameter navigation map, illustrate the available menus within that security level. The Main Window is presented when the **MODE** button is selected

while the operator is at the last available menu screen within the current security level.

The Keypad

There are five capacitive touch keys or buttons on the front panel. The keypad allows the user to select or change parameters & settings, clear alarms and navigate throughout the ITC-FS programming areas. See Figure 3 shown below:



Figure 3

The function of each key is as follows:

KEY	FUNCTION
MODE	Allows the user to Navigate between Menus & Main Window
UP	<ol style="list-style-type: none"> 1. Within a Menu, Scroll UP to next Parameter or Setting within that Menu 2. When viewing an adjustable parameter or setting, increments that parameter UP to the next available value. For a quick scroll, push and hold the key.
DOWN	<ol style="list-style-type: none"> 1. Within a Menu, Scroll DOWN to next Parameter or Setting within that Menu 2. When viewing an adjustable parameter or setting, increments that parameter DOWN to the next available value. For a quick scroll, push and hold the key.
ENTER	<ol style="list-style-type: none"> 1. To accept a parameter or setting that has been entered or changed. 2. Press to accept the change when viewing an adjustable parameter or setting. 3. When in LOGIN Screen, press to advance to next security digit.
RESET	Resets or clears all alarms

Programming the ITC-FS

The ITC-FS is pre-programmed with default parameters and settings that allow it to function “right out of the box”. To change any of the parameters or settings on the ITC-FS, you must access the appropriate menu(s): Temperature Menu, Current Menu, Control Menu, Comms (communications) Menu or System Menu.

To access any of these menus, press the **MODE** button on the keypad. You will be presented with the Login screen:

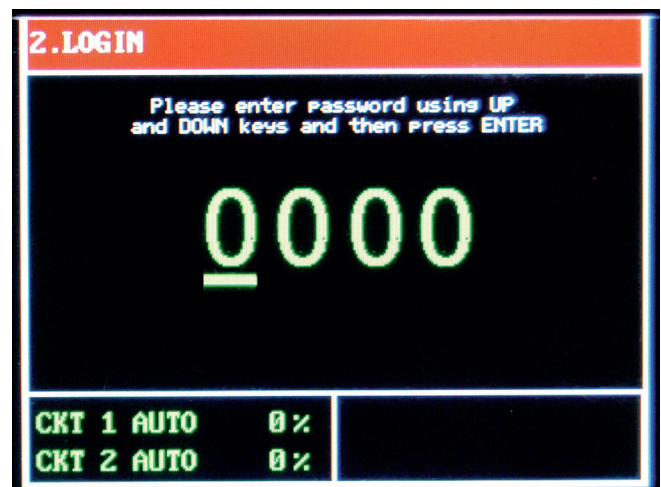

Press **ENTER** to advance to the next digit.

Security Levels

You must first enter a passcode that is aligned with the menu that you wish to access. In most cases, limited access to certain programming areas is desired. The most frequently used parameter settings have the lowest level of security. Invalid passcodes will not be accepted and you will be returned to the LOGIN Screen.

Initial factory set passcodes for the Security levels below are:

Security Level	Passcode	Available Programming Menus
1	0011	Temperature Menu Only
2	0034	Temperature & Current Menus Only
3	0063	Temperature, Current, Control, Comms & System Menus

You will be returned to the main screen if no buttons are depressed within a 30 second time frame.

Passcodes may be reprogrammed within the Systems Menu. These codes should be kept in a secure place.

The Temperature Menu

Security Levels 1, 2 & 3



The Temperature Menu provides access to the Temperature based parameters: Temperature Setpoint, Low Temperature Alarm & High Temperature Alarm for Circuits 1 and 2 (when available).

3. Temperature Menu	
Temperature Setpoint	Process Temperature Variable
Low Temperature Alarm	Lower limit of the Process Temperature Variable at which the system goes into alarm state. This alarm may be turned OFF by going one increment beyond the Lowest setting.
High Temperature Alarm	Upper limit of the Process Temperature Variable at which the system goes into alarm state. This alarm may be turned OFF by going one increment beyond the Highest setting.

The Current Menu

Security Levels 2 & 3

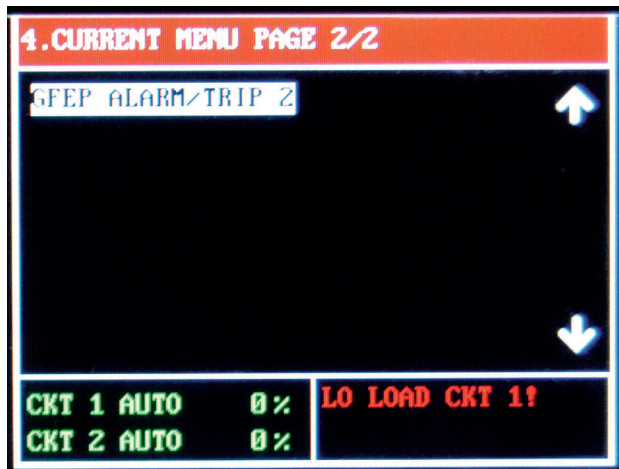
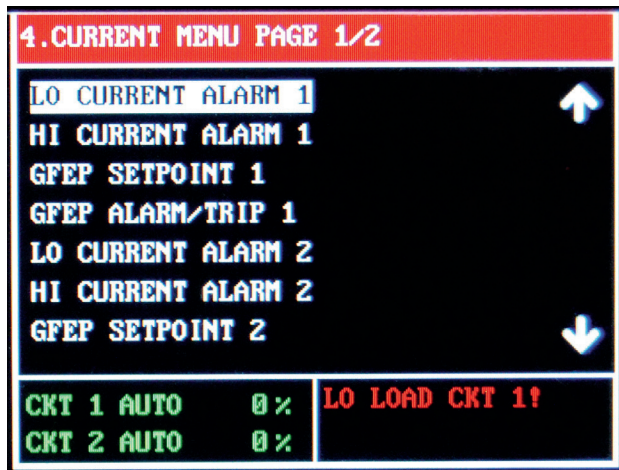

The Current Menu provides access to the current and GFEP based parameters: Low Current Alarm, High Current Alarm, GFEP Setpoint & GFEP Alarm/Trip for Circuits 1 and 2 (when available).

NOTE: When operating a 2-circuit ITC, if circuit 2 (top-board) is not being used, set the GFEP setpoint 2 setting to “OFF”

4. Current Menu		
Low Current Alarm	Lower limit of the Load Current Variable at which the system goes into alarm state. This alarm may be turned OFF by going one increment beyond the Lowest setting.	
High Current Alarm	Upper limit of the Load Current Variable at which the system goes into alarm state. This alarm may be turned OFF by going one increment beyond the Highest setting.	
GFEP Setpoint	Upper limit of the Ground Fault Equipment Protection Variable at which the system goes into alarm state. NOTE: to determine High current circuit value. Reference installation manual.	
GFEP Alarm/Trip	Action taken by controller when the GFEP Setpoint alarm condition is achieved. The options are:	
	1. Alarm Only, Non-Latching	Output remains at selected output %. Alarm clears when sensed GFEP current is 5mA < GFEP setpoint
	2. Alarm & Trip, Non-Latching	Output goes to 0% (off) while in alarm state. Alarm clears when sensed GFEP current is 5mA < GFEP setpoint
	3. Alarm Only, Latching	Output remains at selected output %. Alarm condition may only be cleared with a manual reset.
4. Alarm & Trip, Latching	Output goes to 0% (Off) while in alarm state. Alarm condition may only be cleared with a manual reset.	

The Control Menu

Security Level 3

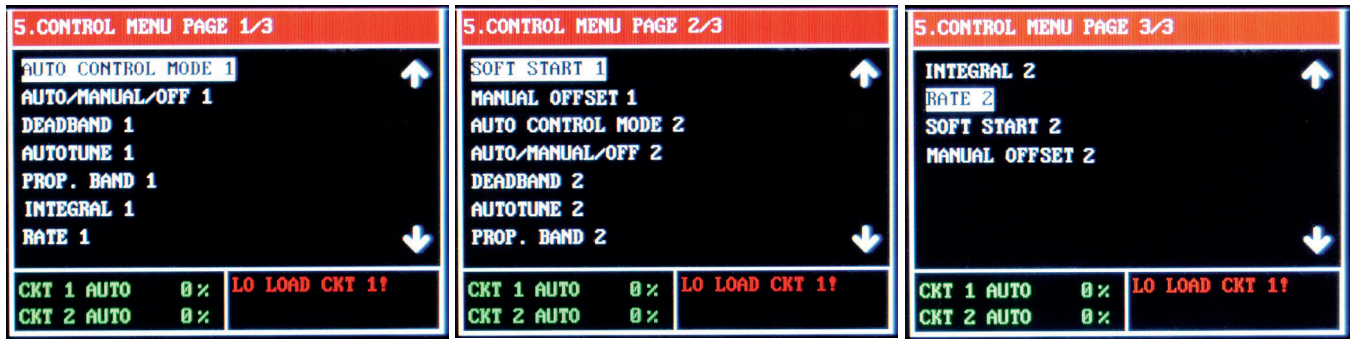

The Control Menu provides access to the types of Automatic Control, Mode of Operation, the parameters which influence the control algorithms and the Soft Start function: Auto Control Mode, Auto/Manual/Off Control, Deadband, Autotune, Proportional Band, Integral, Rate (Derivative), Soft Start function and Manual Offset.

5. Control Menu	
Auto Control Mode	When the ITC-FS is in AUTO Mode (see AUTO/MANUAL/Off parameter), the choice of Automatic Control is either PID or ON/OFF Mode.
Auto/Manual/Off (Mode of Operation)	Determines the type of Control Operation: Automatic, Manual or Off. Automatic Control: Select Auto. This allows On/Off control. Manual Control: Select 1 – 100. This is the % power output. Off: Select 0. This equates to 0% output, which turns off that circuit. NOTE: The Soft Start function will only engage when the ITC-FS is in AUTO Mode
Autotune	The ITC-FS Autotune function establishes the individual P, I & D (Proportional Band, Integral & Derivative) control modes. These modes help to bring the process variable to the setpoint temperature as quickly as possible. In order to properly calculate the P, I & D modes, the Autotune program requires a 25 degree rise in sensed temperature after initiating the program. If within 30 minutes the temperature will not reach its setpoint, the Autotune algorithm will be canceled and old PID values will be used. Once the Autotune feature is activated, you must not change the menu page until the Autotune algorithm is completed. Changing the page will cause the Autotune algorithm to shut down. The Autotune function is a one-time algorithm set up of the P, I & D control modes. Should your process variables change significantly, it is suggested to that the Autotune feature be turned off and then reinitiated.
Deadband	Active ONLY when the ITC-FS is in Auto Mode & under On/Off Control The temperature range equally divided above & below the temperature set point, where the controller will not take corrective action. Example: A setting of “10” for the deadband will result in a deadband that is 5 degrees above and below the temperature setpoint.
Proportional Band, P	Active ONLY when the ITC-FS is in Auto Mode & under PID Control The Proportional Band (P), the Integral (I) & Derivative (D) are modes of control that work in union to bring the process variable to setpoint as smoothly and quickly as possible. The P, I & D will be automatically established during the Autotune procedure (see above). Additionally, the P, I & D may all be manually established by the user. Great care should be taken when manually establishing the P, I & D. Proportional Band: The temperature range above and below the temperature set point.
Integral, I (Automatic Reset)	
Derivative, D (Rate)	
Soft Start	Will only be available while the Mode of Operation is set to AUTO. Options are On or Off.
Manual Offset	Only available while the Mode of Operation is set to AUTO & under PID Control The Manual Offset may be used in conjunction with the PID variables to assist in Tuning the controller. Typically, heat trace applications will not require any Manual Offset adjustment. Manual Offset allows the user to preprogram the approximate power output (%) requirement at the setpoint. This has been proven to reduce the time needed to align the process temperature with the setpoint temperature. As a rule of thumb, relatively light heating loads will require smaller Manual Offset values. The Manual Offset is a percentage output with a range of 0 (0%) to 1000 (100%) and a default of 500 (50%).

The Soft Start Function

The Soft Start function is located within the Control Menu page. The Soft Start function will operate independently on each circuit.

To limit inrush current on the overall system, an inherent characteristic of self-regulating/limiting heating cable, a proprietary Soft Start algorithm is applied during system start-up. This will ONLY occur while the mode of operation is set to AUTO and Soft Start feature is turned ON. The Soft Start program will increment output by 1% every 1 second until the desired temperature is reached or the output % achieves 100%.

After the Soft Start program completes its cycle, the Automatic Control Mode of the system will return to either PID or ON/OFF control, depending on what was selected by the user. The Soft Start Program will not function if the control mode is set to Manual.

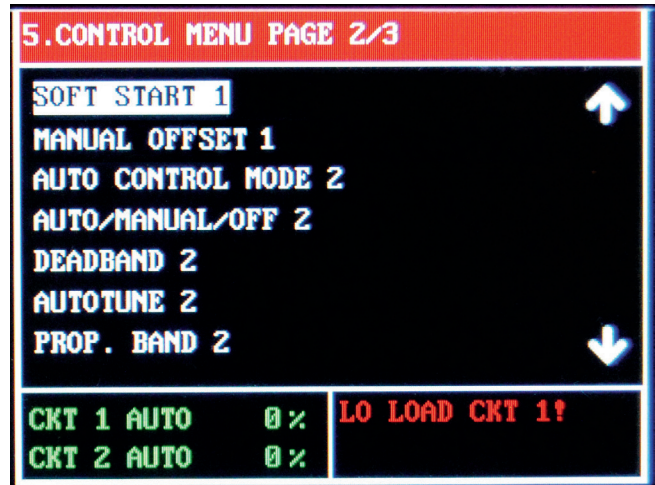

The Comms Menu (Communications)

Security Level 3

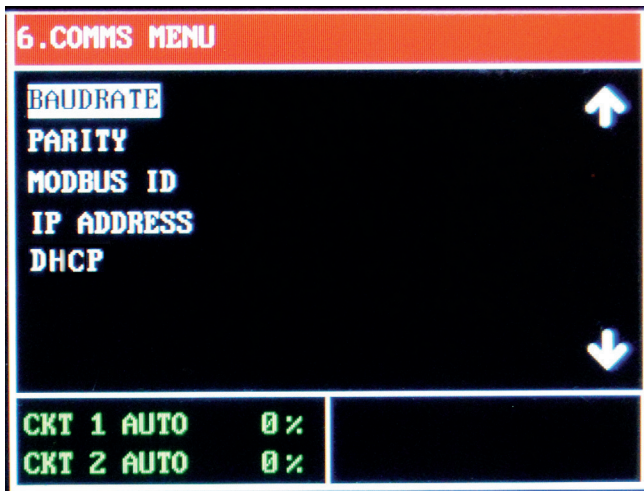

The Comms Menu provides access to the settings for Serial Communications, Modbus RTU/RS-485 or the optional TCP/Ethernet Communications. These communications settings include: Baud Rate, Parity, Modbus ID, IP Address and DHCP.

Modbus RTU requires that you know or define baud rate, character format (Parity), and slave ID (aka slave address, unit number, unit ID). A mismatch in any of these will result in no communication. Likewise, an incorrect IP address will result in no communication on an IP Network.

Note: See Modbus Communications Addendum for detailed register addresses and other Modbus settings.

6. Comms Menu	
Baud Rate	Data transmission speed in Serial Communications, in Hertz (Hz). The range offered by the ITC-FS is 2.4k, 4.8k, 9.6k, 19.2k, 38.4k, 56.0k
Parity	The parity bit is to be set to NONE, EVEN or ODD.
ModBus ID	This is the Identification or Address of the ITC Unit on a Modbus Network. The ID shall be any number from 1 to 255.
IP Address	<p>The Internet Protocol (IP) Address is the address or identifier of a device on a network, such as Modbus TCP/Ethernet, which employs the internet protocol to communicate. Assignment of the IP address may be accomplished in one of two ways:</p> <ol style="list-style-type: none"> 1. Automatically assign (Default). (The DHCP Selection must be "USE") The IP address will be automatically established via the customer's DHCP. 2. Manually assign. (The DHCP Selection must be "DO NOT USE") Select "DO NOT USE" when in the DHCP menu, then enter the appropriate IP Address via the UP/DOWN arrow keys & ENTER button to accept. <p>NOTE: One MUST cycle power to the unit AFTER changing the status of the DHCP (USE ↔ DO NOT USE) and prior to obtaining a new IP Address.</p>
DHCP	<p>DHCP (Dynamic Host Configuration Protocol) Status: Use or Do Not Use.</p> <p>This impacts whether the IP Address is to be automatically assigned by the host DHCP Server or manually entered by the operator. See IP Address above.</p> <p>USE – Select USE if you desire to have the IP Address automatically assigned to the unit by the resident DHCP.</p> <p>DO NOT USE – Select DO NOT USE if you desire to manually assign an IP Address to the ITC-FS unit.</p> <p>NOTE: One MUST cycle power to the unit AFTER changing the status of the DHCP (USE ↔ DO NOT USE) and prior to obtaining a new IP Address.</p>

Manually Assign IP Address (Static IP Address)

The factory default of the ITC-FS is to have the IP Address assigned automatically by the host DHCP Server. However, one may wish to manually assign or establish a Static IP Address. Follow these instructions below to accomplish this:

1. To manually assign the IP address (if not using DHCP server), navigate to the COMMS menu by logging in and then pressing the MODE key until the COMMS menu is observed.
2. Use the DOWN or UP keys to navigate down to **DHCP** within the COMMS menu, and then press ENTER.

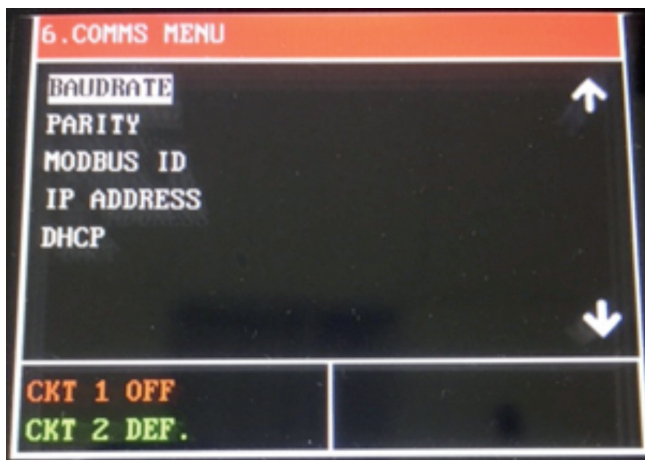

3. Use the DOWN or UP keys to toggle the selection between **USE** and **DO NOT USE**. Make sure that **DO NOT USE** is displayed, then press ENTER to confirm selection.



NOTE: After pressing ENTER, power to the controller must be cycled for the change in the DHCP setting to take effect.

4. Use the DOWN or UP keys to highlight **IP ADDRESS**, then press ENTER key to edit the IP Address:

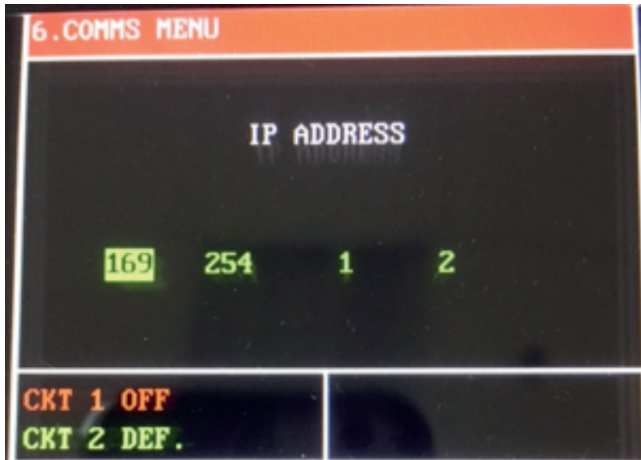

- a. The **IP ADDRESS** is composed of four fields, each with a value range from 0 to 255.
- b. Use the UP and DOWN keys to adjust a field value.
- c. Use the RESET key to toggle between any of the four fields being edited.
- d. To complete and establish a new IP Address, press the ENTER key to return to the COMMS MENU.

Automatically Assign IP Address

As previously mentioned, the factory default of the ITC-FS is to have the IP Address assigned automatically by the host DHCP Server. However, if the IP Address was obtained manually and now the desire is to have it established automatically from a DHCP server, the following steps must be taken:

1. Navigate to **DHCP** within the COMMS menu, and then press ENTER.

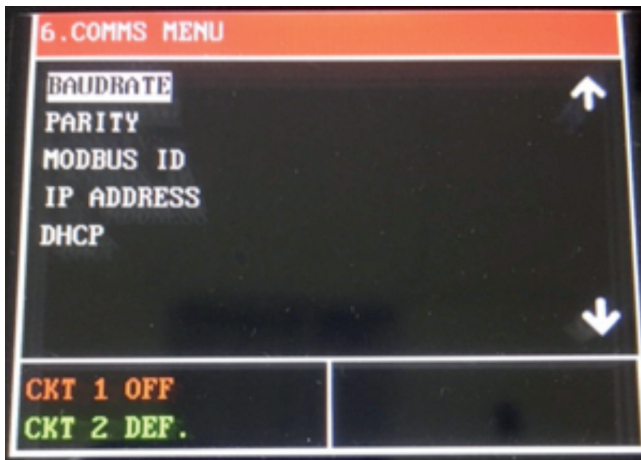

2. Use the DOWN or UP keys to toggle the selection between **USE** and **DO NOT USE**. Make sure that **USE** is displayed and then press ENTER to confirm selection.



NOTE: After pressing ENTER, power to the controller must be cycled for the change in the DHCP setting to take effect.

The Systems Menu

Security Level 3

The System Menu provides access to system information and system settings for the ITC-FS. Items contained in the System Menu include: Firmware Version of the ITC-FS, Button Sound for Keypad interaction, Units (Temperature), Temperature Sensing Type, Failed Sensor Output, (Security) Password for Levels 1, 2 & 3, Alarm State (normally closed) Restore to Default (Settings & Parameters).

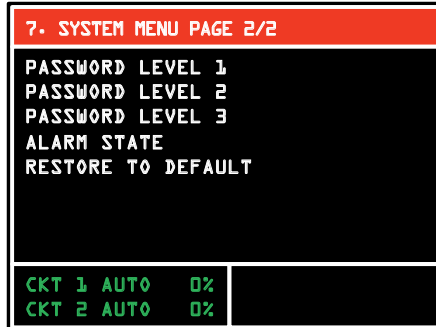
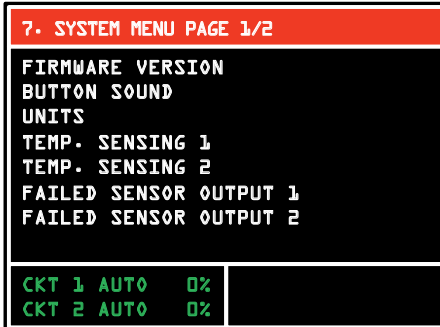

7. System Menu	
Firmware Version	Identifies the Firmware Release of your ITC-FS.
Button Sound	The Button Sound may be kept ON or turned OFF
Units	Temperature Units, Fahrenheit or Celsius
Temp Sensing 1	<p>The ITC-FS accepts two RTD inputs per channel. In Auto Control Mode, the output of each circuit will function according to the Temp Sensing Setting. However, when in Manual Mode, the Output will only consider the Output % as selected by the User.</p> <p>The following settings and their respective function are available when in AUTO Mode:</p> <ul style="list-style-type: none"> • Single – Output is controlled by the Ambient sensed temperature of RTD1B sensor. The 2nd RTD1A Sensor is used for alarming.

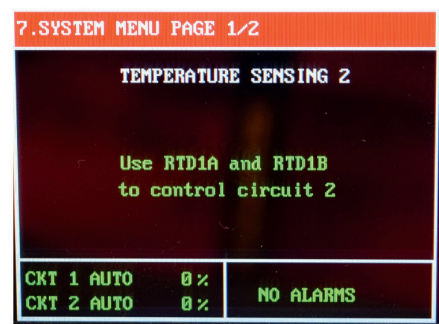
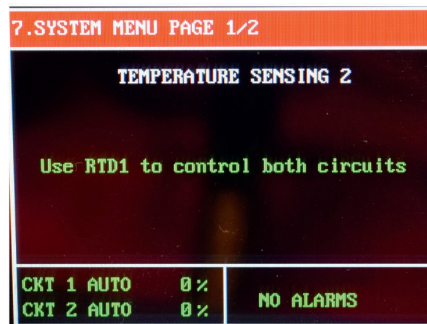
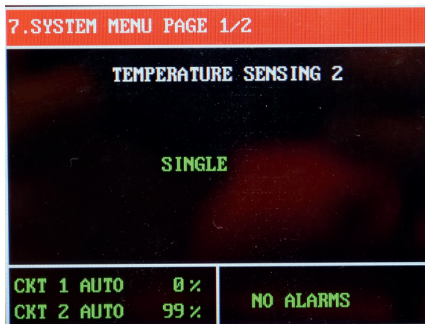

Temp Sensing 2	<p>The ITC-FS accepts two RTD inputs per channel. In Auto Control Mode, the output of each circuit will function according to the Temp Sensing Setting.</p> <p>The following settings and their respective function are available when in AUTO Mode:</p> <ul style="list-style-type: none"> • Single – Output is based on the Ambient sensed temperature of only one RTD sensor. The 2nd RTD Sensor is used for alarming. • Use RTD1B to control both circuits-Output is controlled by the sensed ambient temperature from RTD1B. Alarms will be sensed by RTD1A (CKT #1) and RTD2A (CKT #2). • Use RTD1A and RTD1B to control CKT #2- both outputs are controlled by ambient RTD1B, alarms for both circuits are controlled by RTD1A sensor.
	<p style="text-align: center;">**IMPORTANT CONSIDERATIONS**</p> <p>The ITC-FS assumes a failed sensor condition if the realized temperature is either below -100°F or above 1500°F. A failed RTD sensor (shorted or open) will send a faulty sensed temperature to the controller that exceeds these thresholds. Therefore, the user must understand the output of the ITC-FS when a sensor fails.</p> <p><u>Failed Sensor Operation</u></p> <ol style="list-style-type: none"> 1. All Temp Sensing Configurations – In Failed (Open or Shorted) RTD condition, the ITC-FS will switch to Manual Mode. Output will be per specified % by user. Failed Sensor condition will be flash-ing on the LCD screen and alarm LED will illuminate.
Passwords 1, 2 & 3	<p>Default Security Level Passwords may be changed by the user within the System Menu. See “Security Levels” above for more detail.</p>
Alarm State	<p>Alarm State is Normally Closed.</p>
Restore to Default	<p>This operation allows the user to clear all custom settings and parameters and restore the ITC-FS to its original factory state.</p>

Current Sampling

All active loops are individually tested for 2 seconds every 2 minutes. During the test, a current load value is updated on the yellow bar located on the Main Window

and a new GFEP current is automatically and continuously calculated. The Yellow Load LEDs will be illuminated during the sampling test.

Alarms

Any alarm condition will be displayed in the bottom right corner of the Main Screen. Additionally, a red LED will be illuminated on the front panel under "ALARM".

The table below illustrates the different types of alarm where “#” represents circuit number and “X” represents either sensor A or B

Alarm Type	Display	Solution
Open Sensor	SENS #X ERROR	Check if your RTD is correctly connected to the unit or damaged. Alarm clears automatically. Output will switch to Default Mode. Replace RTD if necessary.
Shorted Sensor	SENS #X ERROR	Check if your RTD is correctly connected to the unit or damaged. Alarm clears automatically. Output will switch to Default Mode. Replace RTD if necessary.
Low Temperature	LO TEMP CKT #!	Sensed temperature is below Lo Temp Alarm Setpoint. Alarm will be cleared automatically when the sensed temperature is greater than the Low Temperature Alarm Setpoint, + 5 deg
High Temperature	HI TEMP CKT #!	Sensed temperature is above High Temp Alarm Setpoint. Alarm will be cleared automatically when the sensed temperature is less than the High Temperature Alarm Setpoint, - 5 deg
High Load	HI LOAD CKT #!	Sensed load current is above Hi Current Alarm Setpoint. Alarm will be cleared automatically when the sensed current < Current Hi Setpoint - 0.5 Amp
Low Load	LO LOAD CKT #!	Sensed load current is below Current Lo Setpoint. Alarm will be cleared automatically when the sensed current > Current Hi Setpoint + 0.5 Amp
High GFEP	HI GFEP CKT #!	Sensed GFEP current is above the GFEP Hi Setpoint. Alarm will be cleared automatically when the sensed current < Current Hi Setpoint - 5 mA
Abnormal Operation	Abnormal OP CKT #!	Check pipe temp and make sure unit is operating correctly and SSR has not failed. Alarm will need to be manually reset by pressing the reset key on the front of the unit. Alarm will be present when controller is not calling for heat but there is current present on the line or controller is calling for heat but there is no current on the line.

Important Note:

Please go to Page 29 to see Wiring of Alarms to FACP

Dimensions

		H	W	D	F	B	M
Fiberglass Enclosure	Inch	10.3	8.5	8.0	1.2	1.8	3.0
	cm	26.2	21.3	19.7	3.2	4.4	7.6

ITC-FS Controller

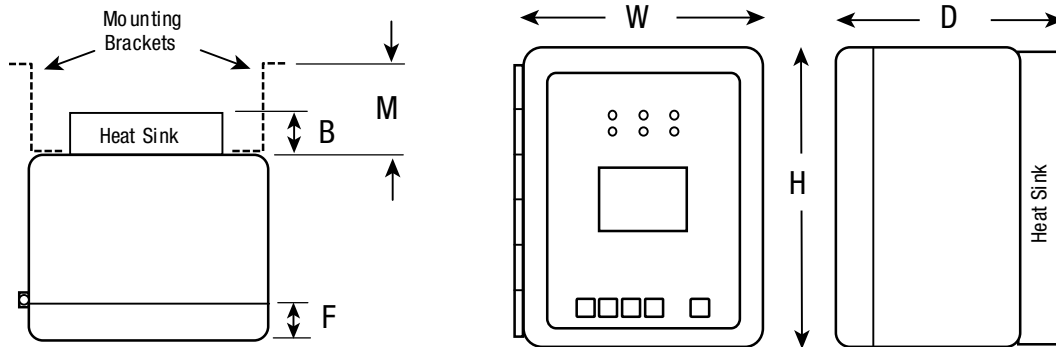

Wall Mount Brackets

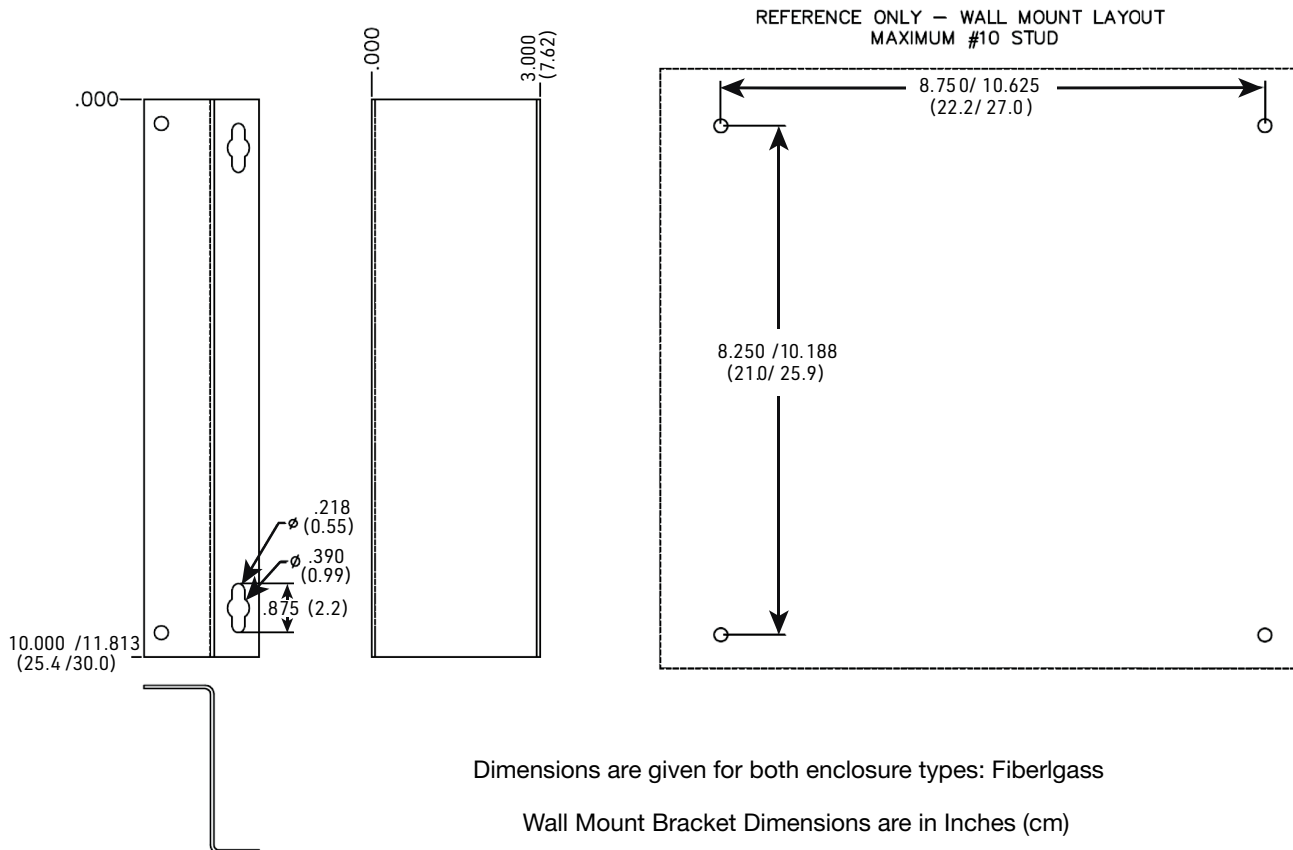

Default Settings

Below is the ITC-FS parameter settings chart organized by Menu Screen. It includes the default, minimum, maximum and / or the range of settings, where applicable.

The chart is for either 1 or 2 circuit units.

Parameter Defaults, Min., Max. & Range & User Settings					
Screen Menu & Parameter					
3. Temperature Menu	Default	Min.	Max.	Also	User Settings
Temp Setpoint 1	40°F	35°F	75°F		
Lo Temp Alarm 1	35°F	20°F	150°F		
Hi Temp Alarm 1	35°F	20°F	150°F		
Temp Setpoint 2	45°F	35°F	75°F		
Lo Temp Alarm 2	40°F	20°F	150°F		
Hi Temp Alarm 2	150°F	20°F	150°F		
4. Current Menu	Default	Min.	Max.	Also	User Settings
Low Current Alarm 1	0.1 A	0.1 A	50.0 A	Off	
Hi Current Alarm 1	40.0 A	0.1 A	50.0 A	Off	
GFEP Setpoint 1	30 mA	30 mA	150 mA		
GFEP Alarm/Trip 1	Alarm Only	Alarm Only, Alarm & Trip; Latching & Non Latching			
Low Current Alarm 2	0.1 A	0.1 A	50.0 A	Off	
Hi Current Alarm 2	40.0 A	0.1 A	50.0 A	Off	
GFEP Setpoint 2	30 mA	30 mA	150 mA	Off	
GFEP Alarm/Trip 2	Alarm Only	Alarm Only, Alarm & Trip; Latching & Non Latching			
5. Control Menu	Default	Min.	Max.	Also	User Settings
Auto Control Mode 1	On / Off	On / Off	PID		
Auto / Manual / Off 1	Auto	0	100	Off	
Deadband 1	10	2	100		
Autotune 1	Off	Off	On		
Proportional Band 1	20	1	100		
Integral 1	500	0	9999		
Rate 1	1	0	500		
Soft Start 1	On	Off	On		
Manual Offset 1	500	0	1000		
Auto Control Mode 2	On / Off	On / Off	PID		
Auto / Manual / Off 2	Auto	0	100	Off	
Deadband 2	10	2	100		
Autotune 2	Off	Off	On		
Proportional Band 2	20	1	100		
Integral 2	500	0	9999		
Rate 2	1	0	500		
Soft Start 2	On	Off	On		
Manual Offset 2	500	0	1000		

Parameter Defaults, Min., Max. & Range & User Settings					
Screen Menu & Parameter					
6. Comms Menu	Default	Min.	Max.	Also	User Settings
Baud Rate	9.6k	2.4k, 4.8k, 9.6k, 19.2k, 38.4k, 56.0k			
Parity	None	Even	Odd	None	
ModBus ID	1	1	255		
IP Address	Optional Feature				
DHCP	Use	Use	Do Not Use		
7. Systems Menu	Default	Min.	Max.	Range	User Settings
Firmware Version	Current Firmware Version				
Button Sound	On	Off	On		
Units	Fahrenheit	Fahrenheit	Celsius		
Temperature Sensing 1	Single				
Temperature Sensing 2	Single	Single, RTD1A to control both circuits, RTD1A and RTD2A to control both circuits			
Failed Sensor Output 1	50%	0%	100%		
Failed Sensor Output 2	50%	0%	100%		
Password Level 1	Password Inputs				
Password Level 2					
Password Level 3					
Alarm State	Normally Closed	Normally Open	Normally Closed		
Restore to Default	Disabled	Up / Down	Up / Down		

Specifications

Input	
Sensor Type	3-wire RTD, 100 Ω PT, 0.00385 $\Omega/\Omega/^{\circ}\text{C}$, 20 Ω balanced lead wire
Number of Sensor Inputs	1 or 2 per Circuit
Sensing Configuration	Range: Single, Low, High, Average
Output	
Power Switching	SSR
Number of Circuits	1 or 2
Capacity	24 Amps per Circuit (Breaker size shall be 30 Amps maximum per circuit or 125% of anticipated load)
Control Types	
PID	Control mode must be set to Auto
Autotune	On or Off
Proportional Band, ($^{\circ}\text{F}$)	Range: 1 – 100
Integral (sec/repeat)	Range: 0 – 9,999
Rate or Derivative, (seconds)	Range: 0 – 500
Manual Offset	0 - 1000 (0% - 100%)
On/Off	Control mode must be set to Auto
Dead band, ($^{\circ}\text{F}$)	Range: 2 – 100
Manual	Range: 0 – 100%
Soft Start, Current Clamping	Enable or Disable
Settings	
Temperature Setpoint (PV)	Range: +35 $^{\circ}\text{F}$ to +75 $^{\circ}\text{F}$ Range: +1 $^{\circ}\text{C}$ to +23 $^{\circ}\text{C}$
Low Temperature Alarm	Range: +20 $^{\circ}\text{F}$ to +150 $^{\circ}\text{F}$ Range: -6 $^{\circ}\text{C}$ to +66 $^{\circ}\text{C}$
High Temperature Alarm	Range: +20 $^{\circ}\text{F}$ to +150 $^{\circ}\text{F}$ Range: -6 $^{\circ}\text{C}$ to +66 $^{\circ}\text{C}$
Low Current Alarm	Range: 0.1 A – 50.0 A, Off
High Current Alarm	Range: 0.1 A – 50.0 A, Off
GFEP	Range: 30mA – 150 mA, +/-2.5% of Span or +/- 3mA
GFEP Alarm Condition	Alarm Only or Alarm & Trip
Output on Sensor Failure	Mode Range: 0 – 100%, Bumpless Transfer to Manual Mode
Audible button depress	Range: On, Off
Security	3 Levels of password protected security
Alarm State	Normal Operation: Closed
Display, HMI, Indication	
Display	3.5" 320 x 240 RGB Full color graphic TFT module
Human Interface	5 Capacitive Touch Input Buttons
LED Indication	Power (Green), Load (Amber), Alarm (Red) – Per Ckt

Alarms			
Alarm Types	Low & High Temperature, Low & High Current, High GFEP, Sensor Failure, Abnormal Operation		
Alarm Relays	1 x DC Alarm Output, 1.8 Amp, Customer Supplied 0 - 50 VDC 1 x AC Alarm Output, 1.8 Amp, Customer Supplied 12-240 VAC		
Alarm Contact State	Mode	Default	Optional
	Normal Operation	Closed	Open
	Alarm Condition	Open	Closed
	Power Off	Open	Open
Communications			
ModBus	RTU/RS485 (2 or 4 wire) & RTU/RS422		
Baud Rate, Hz	2400, 4800, 9600, 19200, 38400, 56000		
Parity	Range: Even, Odd, None		
ModBus ID	Range: 1 – 255		
DHCP	Range: Use, Do Not Use		
Operating & Environmental			
Temperature	-40°F to 104°F (-40°C to 40°C)		
Humidity	Relative Humidity 0% to 90%		
Power Supply	100-277 Vac 50/60Hz		
Protection	IEC IP66		
Enclosure Rating	NEMA 4X FG		
Approvals	UL/ Freeze Protection on Fire Suppression Systems UL file Number: EX27939 (VGNJ)		
Temperature Rating	T4		

Equipment Ratings

Voltage Rating: 100-277 VAC, 50/60 Hz
 Current Rating: 30 amps per Circuit
 Number of Circuits 1 or 2
 Ambient Temperature Rating:..... -40°F to +104°F
 (-40°C to +40°C)
 Altitude Rating:.....Fully rated up to 6,500 Ft
 (2,000 Meters)
 VA consumption rating on electronics:..... 6.0 VA
 The electronics are protected by a 0.5 Amp 350 VAC
 2AG fuse.
 Maximum RTD output 1.25 volts, 7 milliamps
 Pollution Rating Degree 2
 Over Voltage Category III*

* Overvoltage note: Category III is maintained only when a UL Listed VZCA type 2 surge protector is employed between the power source and the ITC-FS unit. The surge protector must be rated at 277 Vac (min) with a maximum surge protection rating of 2500 Vpk. Otherwise the ITC-FS is rated at overvoltage Category II.

Field Wiring Considerations

Torque values for line/load wiring
 terminals: 10-13 in/lbs.
 (1.1-1.5 N-m)

Torque values for RTD 1 & 2 wiring
 terminals: 6-8 in/lbs.
 (.67-.90 N-m)

Torque values for shield grounding/alarm wiring
 terminals: 3-4 in/lbs.
 (.33-.45 N-m)

Terminal Block Gauge Range:
 Line & Load6-18 AWG, Copper
 Alarm & Sensor..... 12-24 AWG

Power Wire Rating

Max Load	Min Breaker	Size (AWG, 90°C)
40A	50A	8
30A	40A	10
20A	25A	12
15A	20A	14

Modbus Wiring Considerations

Environmental influences such as EMI/RFI can compromise the communication signal. Properly designed cables will minimize their influences.

RS485 Max Length..... 2,500 ft. (800 m)

RS485 Wire Specification..... T1/E1/DSL compatible

Example Vendor L-Com (www.L-com.com)

Vendor ItemTSC9928

Customer Wiring

Power, Heater, Alarms & Sensors

These connections are facilitated via the main ITC-FS Board(s)

ITC-FS Main and Standpipe Connection Points

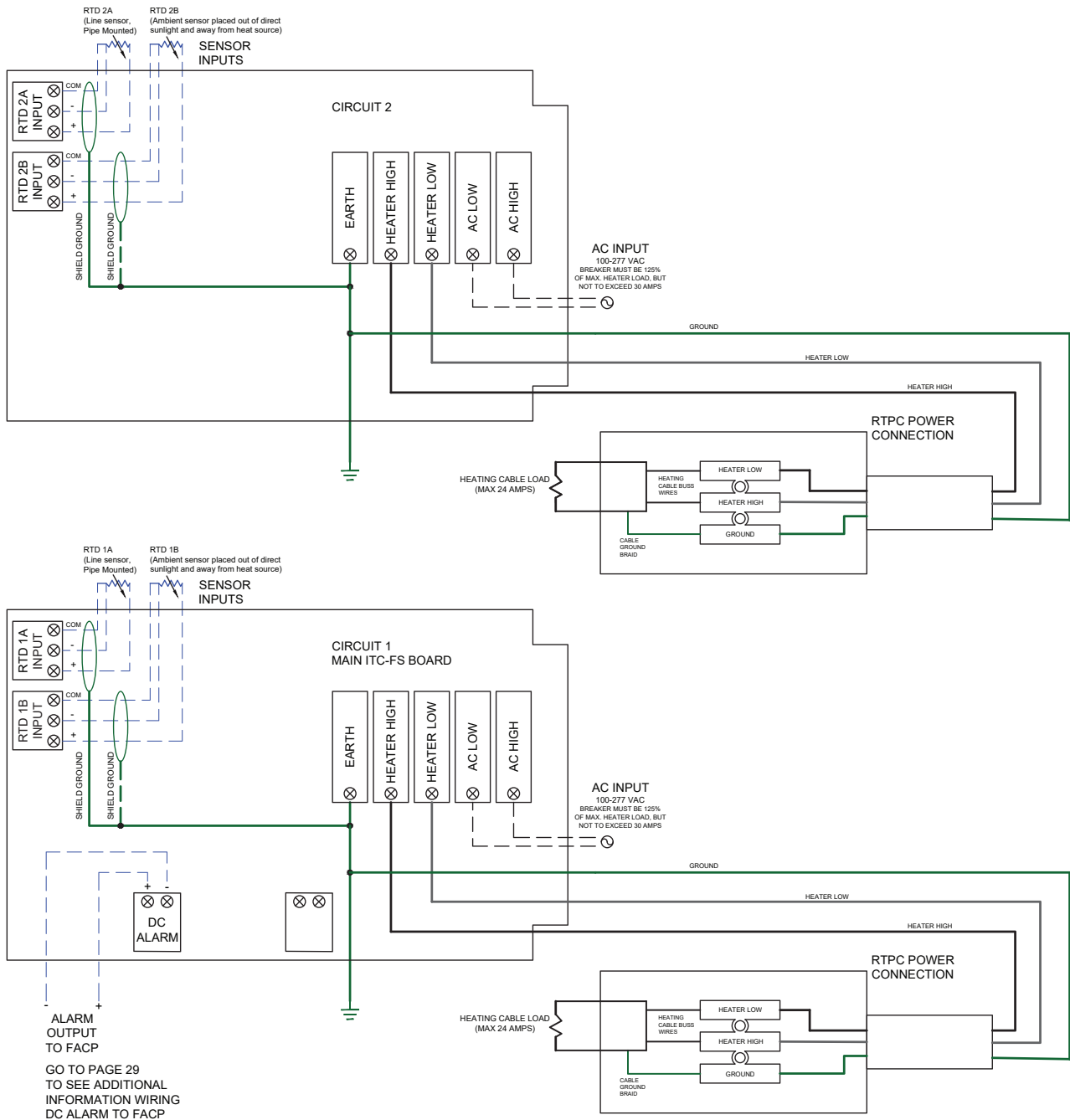

ITC-FS Branch with RTBC-FS

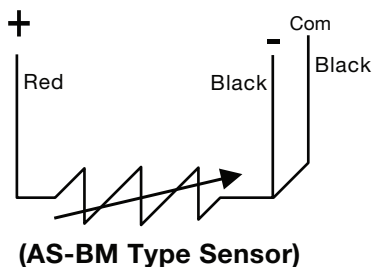
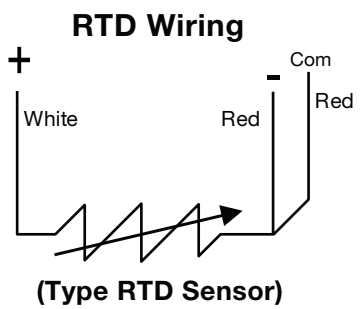
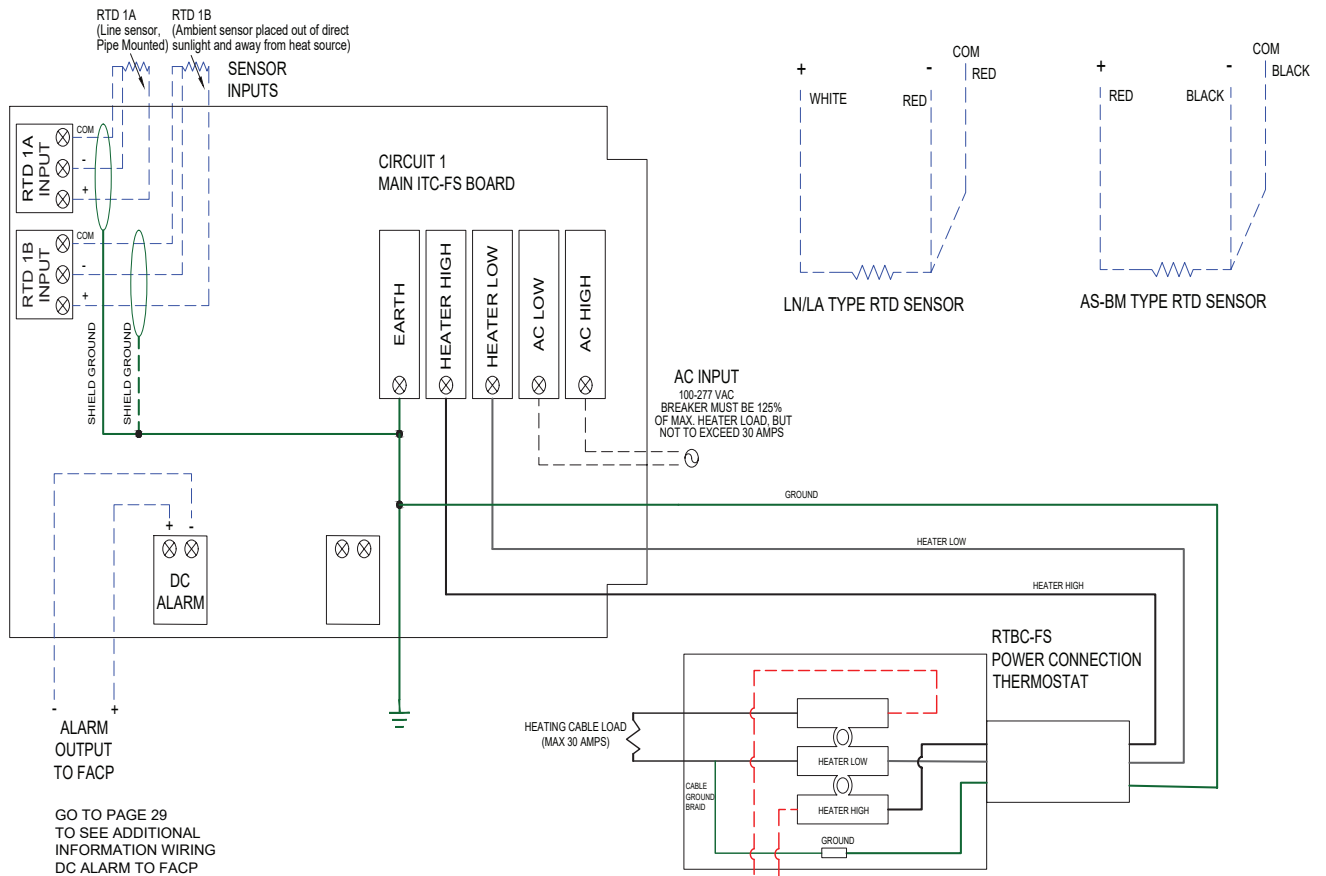

Additional Alarm Wiring Information out to FACP

Option #1: Customer adds a "dry contact" metallic relay stage to DC Alarm Output

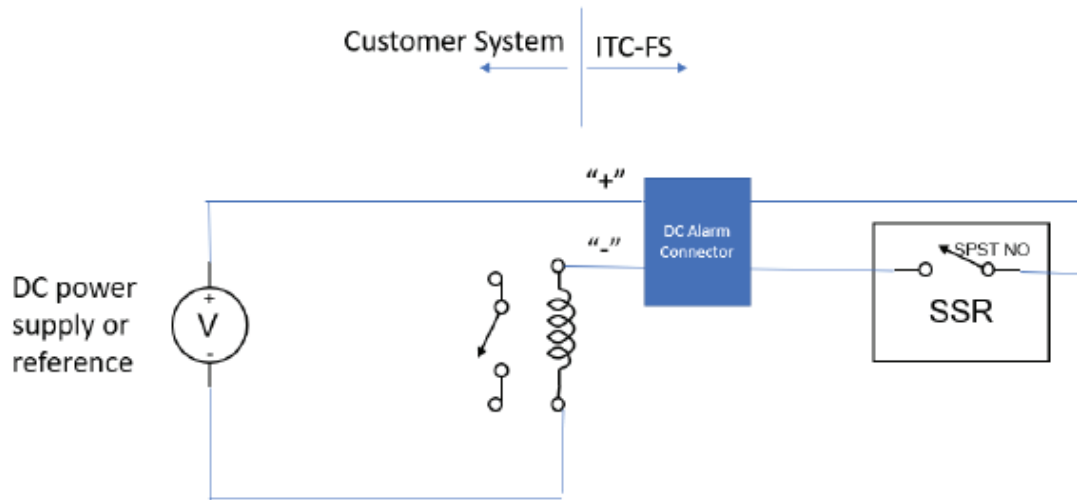

Option #2: Customer connects monitoring equipment directly to ITC-FS DC Alarm Contact

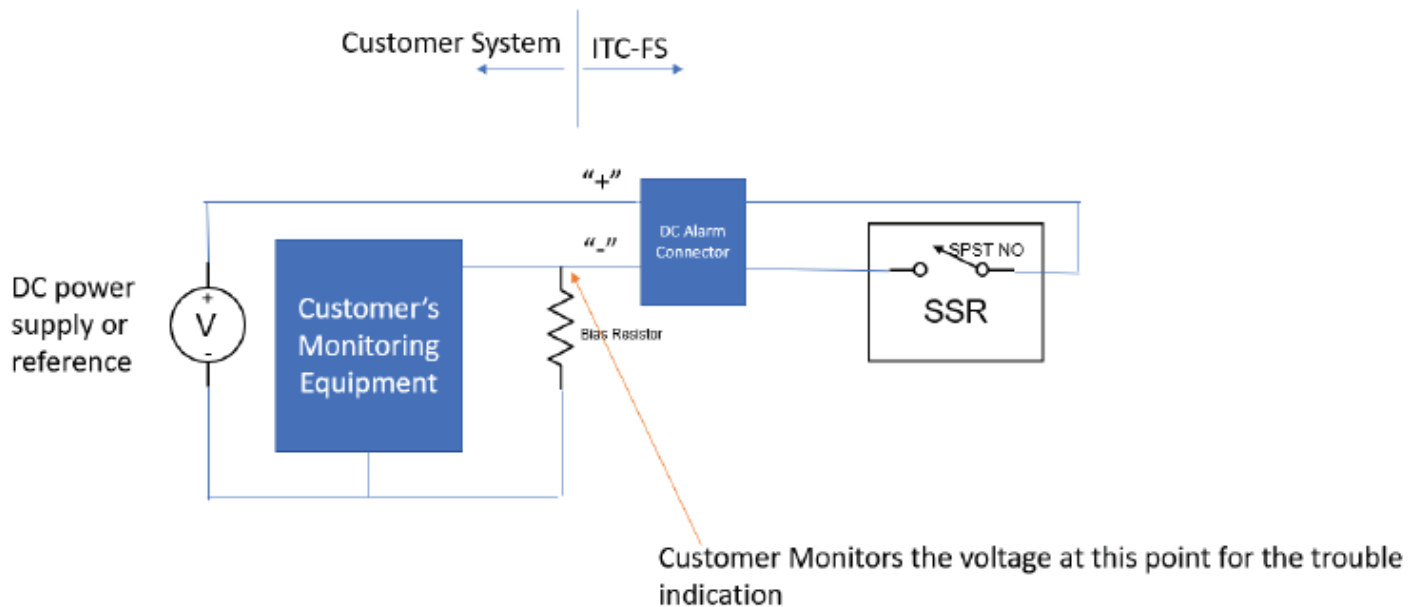

Communications

These connections are facilitated via the **Display Board**.

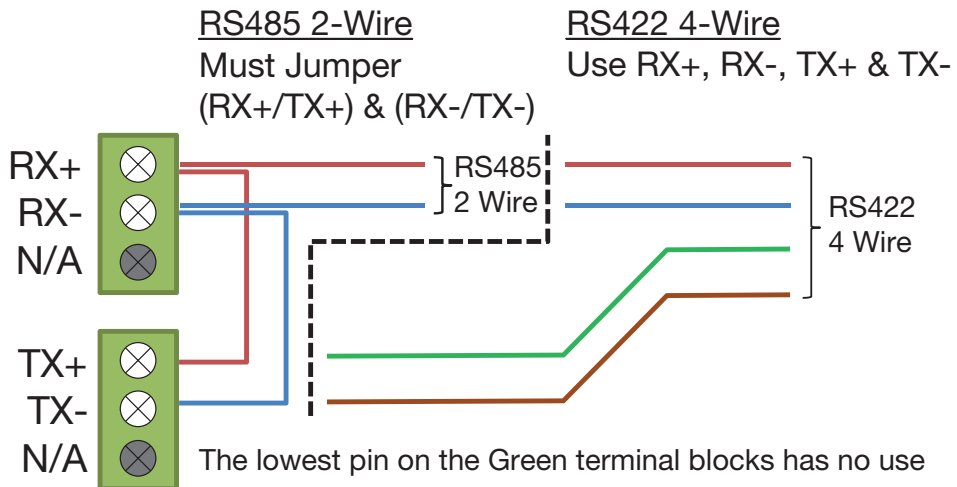
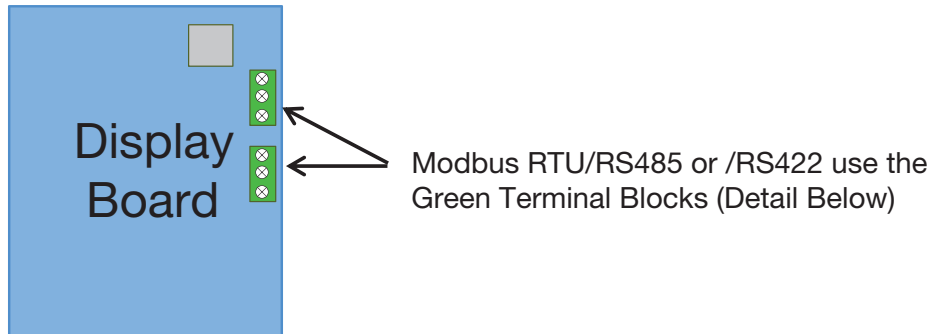

All other Display Board connectors are for factory use ONLY. Connection to these may damage the ITC-FS Unit

Modbus Addendum

Modbus Serial Communications

The ITC-FS supports Modbus serial communications. For a complete description of the Modbus protocol refer to the description provided at <http://www.modicon.com/> or <http://www.modbus.org/>

Physical Layer

The Base address, bit rate and character format are configured via menu interface.

Physical layer configuration settings possible are:

Data rate: 2400, 4800, 9600 (default), 19200, 38400, 56000 bps
Parity: None (default), Even, Odd
Character format: Always 8 bits per character.

The transmitter must not start transmission until 3 character times have elapsed since reception of the last character in a message, and must release the transmission line within 3 character times of the last character in a message.

Note: Three character times = 1.5ms at 19200, 3ms at 9600, 6ms at 4800, 12ms at 2400

Link Layer

A Query (or command) is transmitted from the Modbus Master to the Modbus Slave. The slave instrument assembles the reply to the master. All of the instruments covered by this manual are slave devices, and cannot act as a Modbus Master.

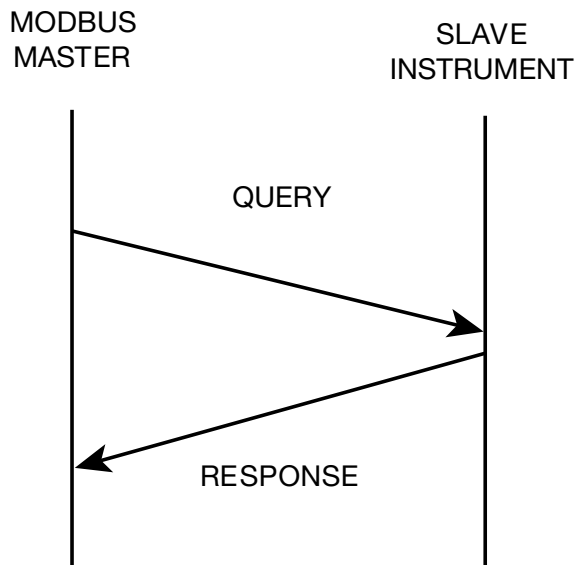

Figure 1. Modbus Link Layer

A message for either a QUERY or RESPONSE is made up of an inter-message gap followed by a sequence of data characters. The inter-message gap is at least 3.5 data character times.

Data is encoded for each character as binary data, transmitted LSB first.

For a QUERY the address field contains the address of the slave destination. The slave address is given together with the Function and Data fields by the Application layer. The CRC is generated from the given address, function and data characters.

For a RESPONSE the address field contains the address of the responding slave. The Function and Data fields are generated by the slave application. The CRC is generated from the address, function and data characters.

The standard MODBUS RTU CRC-16 calculation employing the polynomial $2^{16}+2^{15}+2^2+1$ is used.

Inter-message gap	Address 1 char.	Function 1 char.	Data <i>n</i> char.	CRC Check 2 char.
-------------------	-----------------	------------------	---------------------	-------------------

Device Addressing

The instrument is assigned a unique device address by the user in the range 1 (default) to 255. To change Modbus address, navigate to page 6 of the ITC-FS Menu page and select "MODBUS ID" parameter. Use Up and Down keys to change the value. This address is used to recognize Modbus Queries intended for this instrument. The instrument does not respond to Modbus Queries that do not match the address that has been assigned to it.

The instrument will also accept global Queries using device address 0 no matter what device address is assigned. No responses are returned for globally addressed Queries.

Description of Modbus Register Set

Modbus defines several function types; these instruments support the following types:

Table 1 - Modbus Function Code Set

Function Code	Function Name
03	Read Holding Registers
04	Read Input Registers
06	Write Single Holding Register
16	Write Multiple Holding Registers

Input Registers

Table 2 - ITC-FS 1&2 Circuit Input Registers

Address	Description	Comments
30000	Sensed Temperature Ckt 1	Sensed Temperature Circuit 1
30001	Setpoint Ckt 1	Setpoint Circuit 1
30002	Sensed ground fault current on Ckt 1	Sensed ground fault current on circuit 1
30003	Sensed load on Ckt 1 (expressed as integer number ion tenths of Amp e.g. 154 = 15.4 Amp)	Sensed load on circuit 1 (expressed as integer number ion tenths of Amp e.g. 154 = 15.4 Amp)
30004	Control Output Command on Ckt 1	Control Output Command on Circuit 1
30005	Sensed Temperature on Ckt 2	Sensed Temperature on Circuit 2
30006	Setpoint circuit 2	Setpoint circuit 2
30007	Sensed ground fault current on Ckt 2	Sensed ground fault current on circuit 2
30008	Sensed load on Ckt 2 (expressed as integer number ion tenths of Amp e.g. 154 = 15.4 Amp)	Sensed load on circuit 2 (expressed as integer number ion tenths of Amp e.g. 154 = 15.4 Amp)
30009	Control Output Command on Ckt 2	Control Output Command on Circuit 2
30010	Sensed Ambient Temperature	Sensed Ambient Temperature
30011	Reserved	
30012	Reserved	
30013	Reserved	
30014	Reserved	
30015	Reserved	
30016	Reserved	
30017	Reserved	
30018	Firmware ver CPU 1	
30019	Firmware ver CPU 2	

Holding Registers

Table 3 - ITC-FS 1&2 Circuit Holding Registers

Address	Description	Range	Comments
40000	Units	0-1	0°F; 1°C
40001	Setpoint Circuit 1	-80-1100	Expressed as an integer number
40002	Setpoint Circuit 2	-80-1100	Expressed as an integer number
40003	Control Mode for Circuit 1	0-1	0=PID; 1=ON/OFF
40004	Control Mode for Circuit 2	0-1	0=PID; 1=ON/OFF
40005	Deadband 1	0-10	Expressed as an integer number
40006	Deadband 2	0-10	Expressed as an integer number
40007	Commanded Power Ckt 1	0-100 and 101	Expressed as an integer number e.g 50= 50% (101= Circuit in AUTO mode)
40008	Commanded Power Ckt 2	0-100 and 101...	Expressed as an integer number e.g 50= 50% (101= Circuit in AUTO mode)
40009	Hi Temp Alarm for Ckt 1	-80 - 1150	Expressed as an integer number
40010	Hi Temp Alarm for Ckt 2	-80 - 1100	Expressed as an integer number
40011	Alarm Register Ckt 1	0	Bit state: 1 -alarm , 0 -no alarm Bit # 1 - Sensor 1A Error Bit #2 - Hi Temp Ckt 1 Alarm Bit #3 - Lo Temp Ckt1 Alarm Bit #4 - GFEP Ckt 1 Alarm Bit #5 - Lo Current Ckt1 Alarm Bit #6 - Hi Current Ckt1 Alarm Bit #7 - Reserved Bit #8 - Sensor 1B Error
40012	Alarm Register Ckt 2	0	Bit state: 1 -alarm , 0 -no alarm Bit # 1 - Sensor 2A Error Bit #2 - Hi Temp Ckt 2 Alarm Bit #3 - Lo Temp Ckt2 Alarm Bit #4 - GFEP Ckt 2 Alarm Bit #5 - Lo Current Ckt2 Alarm Bit #6 - Hi Current Ckt2 Alarm Bit #7 - Reserved Bit #8 - Sensor 2B Error
40013	Proportional Band Ckt 1	1-100	Expressed as an integer number
40014	Proportional Band Ckt 2	0-100	Expressed as an integer number
40015	Integral for Ckt 1	0-100	Expressed as an integer number
40016	Integral for Circuit 2	1-100	Expressed as an integer number
40017	Derivative for Ckt 1	0-500	Expressed as an integer number
40018	Derivative for Ckt 2	0-500	Expressed as an integer number
40019	Low Temp Alarm Threshold for Ckt 1	-80 - 1150	Expressed as an integer number
40020	Low Temp Alarm Threshold for Ckt 2	-80 - 1150	Expressed as an integer number
40021	Baudrate	0-4	0- 240 1 - 480 2 - 9600 (default) 3 - 38400 4 - 56000"

Address	Description	Range	Comments
40022	Parity	0-2	0 - NONE 1 - EVEN 2 - ODD
40023	Modbus Slave Address	0-255	Expressed as an integer number
40024	Reserved		
40025	GFEP Alarm Threshold for Ckt 1	30-150	Expressed as an integer number (in mA e.g. 75 = 75mA)
40026	Low Current Alarm for Ckt 1	0.0-100.0	Expressed as an integer number in tenths of Amp (e.g. 250 = 25.0 Amp)
40027	HI Current alarm for Ckt 1	0.0-100.0	Expressed as an integer number in tenths of Amp (e.g. 250 = 25.0 Amp)
40028	GFEP Alarm behavior Ckt 1	0-3	0 - Alarm Only, non latching 1 - Alarm and Trip, non latching 2 - Alarm and Trip, Latching 3 - Alarm Only, Latching
40029	Reserved		
40030	GFEP Hi Alarm Threshold for Circuit 2	30-150	Expressed as an integer number (in mA e.g. 75 = 75mA)
40031	Low Current Alarm for Circuit 2	1.0-100.0	Expressed as an integer number in tenths of Amp (e.g. 250 = 25.0 Amp)
40032	HI Current alarm for Circuit 2	0.0-100.0	Expressed as an integer number in tenths of Amp (e.g. 250 = 25.0 Amp)
40033	Soft Start Circuit 1	0-1	0 - No 1 - Yes
40034	Soft Start Circuit 2	0-1	0 - No 1 - Yes
40035	GFEP Alarm behavior Ckt 2	0-3	0 - Alarm Only, non latching 1 - Alarm and Trip, non latching 2 - Alarm and Trip, Latching 3 - Alarm Only, Latching
40036	Reserved	Reserved	Reserved
40037	Temperature sensing (Circuit 2)	3-5	3- Controller will use sensor 2A for line sensing and sensor 2B for ambient sensing to control ckt 2 4- Controller will use sensor 2A (line sensing) and 1B(ambient sensing) to control ckt # 2 5 - Controller will use sensor 1A and 1B to control ckt 2.
40038	Default output 1	0-100%	Expressed as an integer number (e.g. 75 = 75%)
40039	Default output 2	0-100%	Expressed as an integer number (e.g. 75 = 75%)
40040	Reserved		
40041	Reserved		

Service Contact Information

Chromalox is a global supplier, providing the highest level of customer support. If you should have questions concerning your intelliTRACE™ ITC-FS Controller or need information, you may contact Chromalox at:

Corporate Headquarters Chromalox, Inc.
103 Gamma Drive Pittsburgh, PA 15238 Phone: (412) 967-3800
Customer Service Hotline: 1-800-443-2640

For application questions, you can:

1. Call one of our application engineers for personal assistance at 1-888-996-9258.
2. Visit the technical reference section of our website at www.chromalox.com for downloadable manuals in PDF format.

Limited Warranty:

Please refer to the Chromalox limited warranty applicable to this product at
<http://www.chromalox.com/customer-service/policies/termsofsale.aspx>.

**Chromalox, Inc.
1347 Heil Quaker Boulevard
Lavergne, TN 37086
(615) 793-3900
www.chromalox.com**