

Installation & Operation Manual

IntelliTrace

ISC-Intellitrace Supervisory Controller

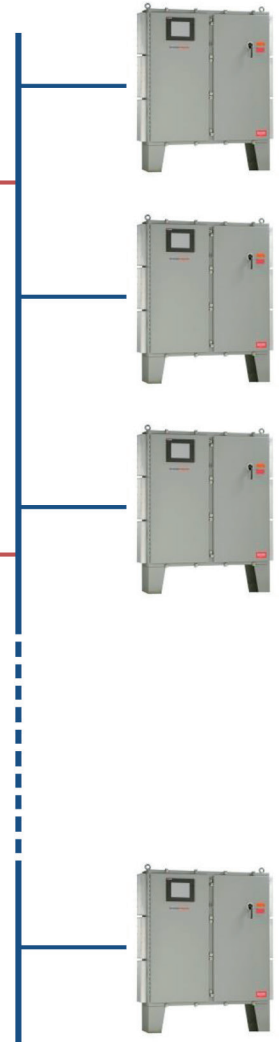

PK520-1
0037-75533
December 2016

Table of Contents

<u>Section</u>	<u>Page</u>
Important Information.....	3
License Agreement.....	3
Safety Precautions	4
Introduction	5
Overview.....	6
System Topography	6
System Navigation	7
PC Requirements	9
IntelliTRACE Supervisory Controller Installation	9
System Configuration.....	10
Initiate IntelliTRACE Panel Network	10
Planning Your IntelliTRACE System	10
Construct Your IntelliTRACE System	11
Security Levels & Password Screen.....	11
Adding Systems	12
Connecting Systems	13
Programming & Editing	14
Setpoints Tab	14
Temperature Units	15
Navigation Note.....	15
Mass Setting	16
Apply Settings Globally	16
Synchronize Settings.....	16
Tuning Tab	19
Control Modes: ON/OFF, PID & Autotune	17
Soft Start Feature	18
I/O (Sensor & Output) Mapping Tab.....	18
Sensor Mapping	18
Output Mapping	20
System Tab.....	21
AutoCycle	21
Number of Current Samples.....	22
Configuring Your System	22
Event (Alarm) Log.....	24
Faults (Alarms).....	25
Clearing Alarms	25
Alarm Troubleshooting	26
Appendix	27
Wiring Considerations.....	27
Service Contact Information.....	28

Important Information

All information, including illustrations, is believed to be reliable. Users, however, should independently evaluate the suitability of each product for their particular application. Chromalox, Inc. makes no warranties as to the accuracy or completeness of the information, and disclaims any liability regarding its use.

Chromalox's only obligations are those in the Chromalox Standard Terms and Conditions of Sale for this product, and in no case will Chromalox, Inc. or its rep-

resentatives, distributors or employees be liable for any incidental, indirect, or consequential damages arising from the sale, resale, use, or misuse of the product.

Specifications are subject to change without notice. In addition, Chromalox, Inc. reserves the right to make changes—without notification to Buyer—to processing or materials that do not affect compliance with any applicable specification.

License Agreement

IntelliTRACE® Supervisory Controller IntelliTRACE® Supervisory Software

(c) Copyright 2011 Chromalox, Inc. All Rights Reserved.

END-USER LICENSE AGREEMENT (“EULA”) FOR THIS SOFTWARE PRODUCT: IMPORTANT-READ CAREFULLY!

This EULA is a binding legal agreement between you (either an individual or a single entity) and the mentioned author of this Software for the SOFTWARE PRODUCT identified above, which includes computer software and may include associated media, printed materials, and “online” or electronic documentation (“SOFTWARE PRODUCT”). By installing, copying, or otherwise using the SOFTWARE PRODUCT, you agree to be bound by the terms of this EULA.

The SOFTWARE PRODUCT is protected by copyright laws and international copyright treaties, as well as other intellectual property laws and treaties. The SOFTWARE PRODUCT is licensed by the author, not sold.

Installation packages created by the SOFTWARE PRODUCT may contain, among other things, a portion of the SOFTWARE PRODUCT, including copyrighted software, proprietary notices, and identifying information (the “Extraction Software”).

You may not alter or modify the Extraction Software. You are not authorized to give to anyone else the permission to modify the Extraction Software.

You may not reverse engineer, decompile, or disassemble any parts of the SOFTWARE PRODUCT except and only to the extent that such activity is expressly permitted by applicable law notwithstanding this limitation.

The Author of this Software expressly disclaims any warranty for the SOFTWARE PRODUCT. You acknowl-

edge that the SOFTWARE PRODUCT is provided “as is” and “with all faults, defects and errors” without warranty of any kind, either express or implied, including, without limitation, the implied warranties or merchantability, fitness for a particular purpose, or non-infringement, and that all use of the Program is at your own full risk. The entire risk arising out of use or performance of the SOFTWARE PRODUCT remains with you.

In no event shall the author of this Software be liable for any damages whatsoever (including, without limitation, damages for loss of business profits, business interruption, loss of business information, or any other pecuniary loss) arising out of the use of or inability to use this product, even if the Author of this Software has been advised of the possibility of such damages. Because some states / jurisdictions do not allow the exclusion or limitation of liability for consequential or incidental damages, the above limitation may not apply to you. In this case the Author of this Software will only be liable for the amount of money you spent for this SOFTWARE PRODUCT in exchange for the return of the product, all copies, registration papers and manuals, and all materials that constitute a transfer of ownership from the customer back to the Software Author.

Without prejudice to any other rights, the Author of this Software may terminate this EULA if you fail to comply with the terms and conditions of this EULA. In such event, you must destroy all copies of the SOFTWARE PRODUCT and all of its component parts.

Safety Precautions

The IntelliTRACE® Supervisory Software monitors and manages equipment that is designed to provide power to electrical heating devices. Before working on or servicing the equipment or heating devices, be sure that all power has been removed and observe all safety precautions. Please refer to the Chromalox ITLS & ITAS IntelliTRACE® Installation Manual & Set-Up Guide for more safety guidance.

Since the IntelliTRACE Supervisory Software, by application extension, is associated with the power ITLS & ITAS distribution equipment, the following safeguards shall also apply:



Throughout the IntelliTRACE® ITAS, ITLS Control Panel Setup Guide, these symbols will alert you to potential hazards. Safety precautions should always be followed to reduce the risk of fire, electrical shock, injury and even death to persons.

Please read all instructions before operating your IntelliTRACE® ITLS, ITAS, ITLS-EXT or ITAS-EXT Control Panel.

To avoid electrical shock or injury, always remove power before servicing a circuit. Personnel working with or near high voltages should be familiar with modern methods of resuscitation. Contact an area supervisor or safety personnel for more information.

⚠ WARNING

HIGH VOLTAGE is used in the operation of this equipment; DEATH ON CONTACT may result if personnel fail to observe safety precautions.

Learn the areas containing high-voltage connections when installing or operating this equipment.

Be careful not to contact high-voltage connections when installing or operating this equipment.

Before working inside the equipment, turn power off and ground all points of high potential before touching them

⚠ WARNING

ELECTRIC SHOCK HAZARD. Any installation involving control equipment must be performed by a qualified person and must be effectively grounded in accordance with the National Electrical Code to eliminate shock hazard.

IntelliTrace

Introduction

The **intelliTRACE** Supervisory Control is designed to monitor and manage multiple Chromalox **intelliTRACE** Control Panels. Each “Panel” must be either a Chromalox **IntelliTRACE** Base Panel or a Base Panel with a single Extension Panel. (When a base panel is coupled with an extension panel, this is often referred to as an **intelliTRACE** “System”). Each Panel (or “System”) must be comprised of 6 - 72 circuits. This includes the ITAS, ITLS, ITASC1D2 and ITLSC1D2 heat trace control panel platforms, including the Extension panel versions.

intelliTRACE provides efficient and secure remote monitoring and parameter value management of hundreds to thousands of individual heat trace circuits.

intelliTRACE is available as a downloadable PC Software program or it may be embedded in an Industrial PC for either ordinary or hazardous areas.

Alarm indication throughout your entire system is visible from 5 separate user-defined levels. From the highest “Corporate” level down to the individual circuit level, **intelliTRACE** provides the user with 100% system-wide monitoring and alarm status at all times.

Local system monitoring and management is performed through the touch screen computer which supervises each individual **intelliTRACE** control panel system. System wide remote access is available at any control station on your network. Additionally, the **intelliTRACE** software package provides the owner with peace of mind with its electronic email of alarm events.

The **intelliTRACE** supervisory control is extremely efficient to set up and manage. Intuitive Windows based system screens and global application of mass parameter value settings will have your system commissioned in minutes, not hours. Navigation to any **intelliTRACE** control panel system is accomplished via 1 to 3 mouse clicks within **intelliTRACE** while individual circuit detail within each panel system is simply one more click away.

intelliTRACE Features:

- Offered as either an Industrial PC for both Ordinary or Hazardous areas or as a Software Program on your Personal Computer (See PC Requirements Section)
- Effective Visual Alarm Status Hierarchy Tree
- Fully Customizable System Identification
- 5 Discrete System Location Monitoring Levels
- Intuitive Windows Based System Screens
- Global Application of Parameter Settings
- Efficient Navigation to all Circuits Within All Systems
- Local and Remote Alarm Indication
- ModBus RTU/RS485 or ModBus/TCP (Ethernet) Communication
- Full Alarm & Monitoring Capabilities on GFEP, Temperature, Sensor, Current Load & Communications
- Electronic Notification (via Email) of Alarm Events
- Multiple Level Security Password Protection
- Individual Circuit Enable/Disable Capability
- Proprietary Soft Start Algorithm
- Facilitates All **intelliTRACE** Control Panel Functionality

Overview

System Topography

The intelliTRACE Supervisory system has three main components: The intelliTRACE supervisory controller, network hub(s) and intelliTRACE controllers & panels. The intelliTRACE software may either be installed on the owners' suitable computer that is properly networked or it may be embedded into an industrial PC that is mounted in its own enclosure.

Each individual intelliTRACE panel provides power management and or distribution to a maximum of 72 circuits. The standard intelliTRACE system manages up to 128 intelliTRACE control panels. Therefore, 9,216 circuits of control are easily be managed by intelliTRACE controller. The panel count may be increased to meet your system needs.

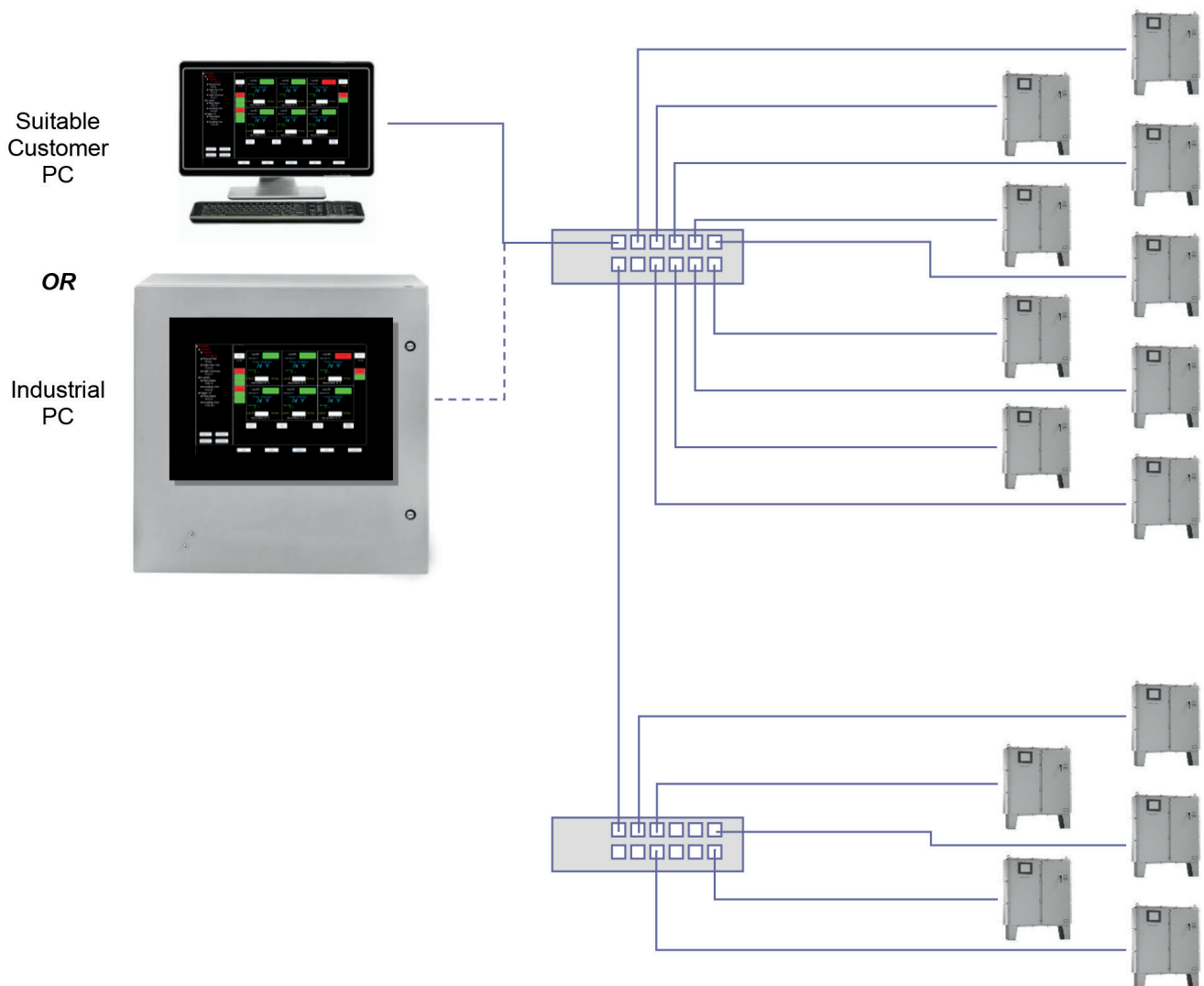

System Navigation

IntelliTRACE supervisory control provides individual circuit health and complete system-wide alarm status at a single glance. There are three major areas visible to the user:

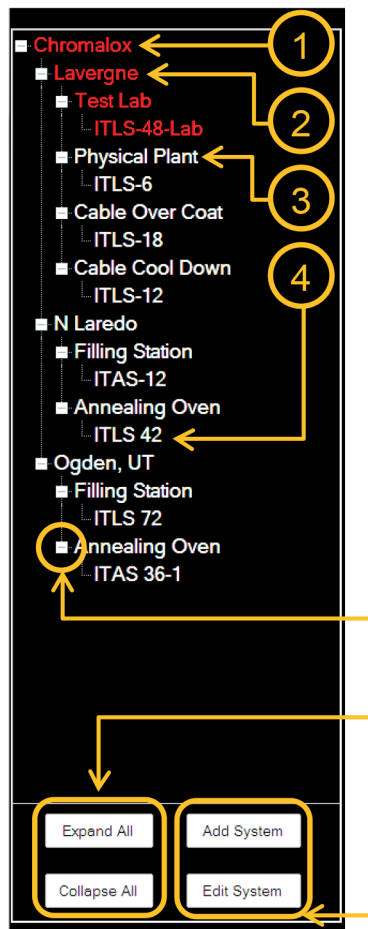
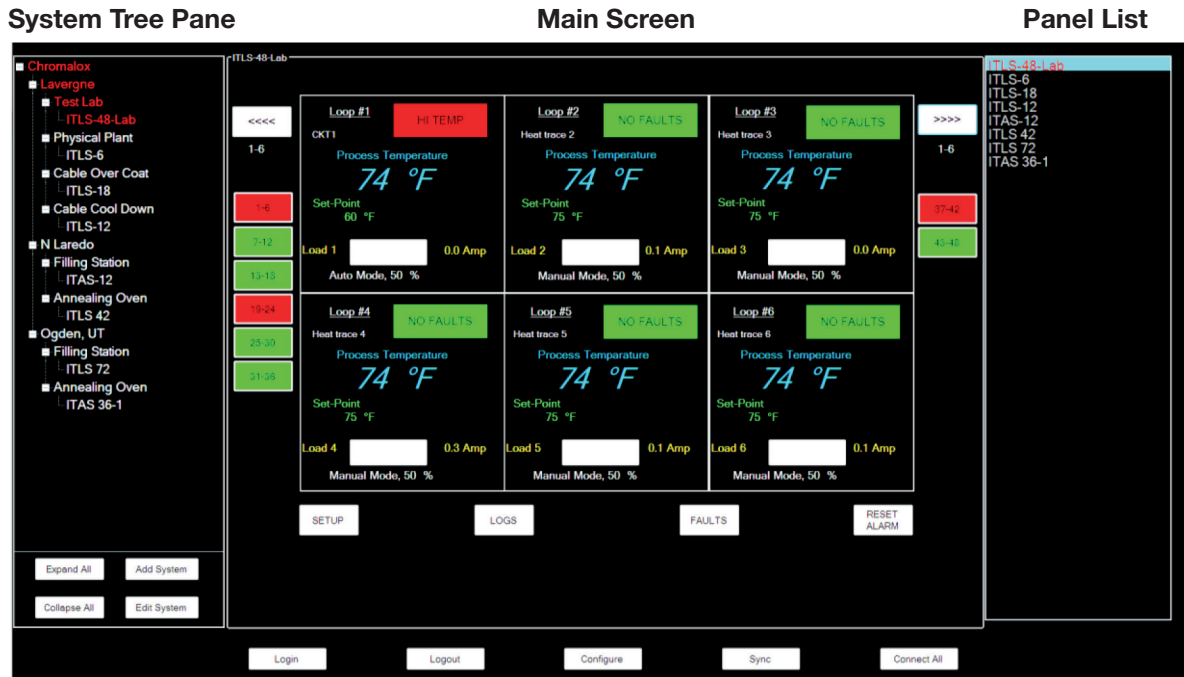

System Tree Pane

The System Tree Pane, on the left, is visual illustration of your system network. It also provides alarm status for all areas that are being monitored and managed by the IntelliTRACE supervisory control.

Red Text indicates that there is a circuit within a certain area of your system that is in the alarm state.

Four levels of your system are visible here:

- 1-Company, 2-Facility, 3-Department, 4-Individual Panel

The System Tree detail may be varied depending on the resolution that you desire to view. Discrete expanding and collapsing control is provided within each level via the + and - switches.

To fully expand or collapse the tree, use the **Expand All** and **Collapse All** buttons at the bottom-left of this pane.

Initial system setup, edits, and additions to your system may be accomplished via the **Add System** & **Edit System** buttons at the bottom-right of this pane.

Main Screen

The Main Screen provides parameter value, control setting detail and the alarm status with condition on six individual circuits at a time. Navigation buttons are also present which provide access to other six circuit groupings, the SETUP page, the LOGS page or the FAULTS page. There are also network connection and system utility buttons on the bottom.

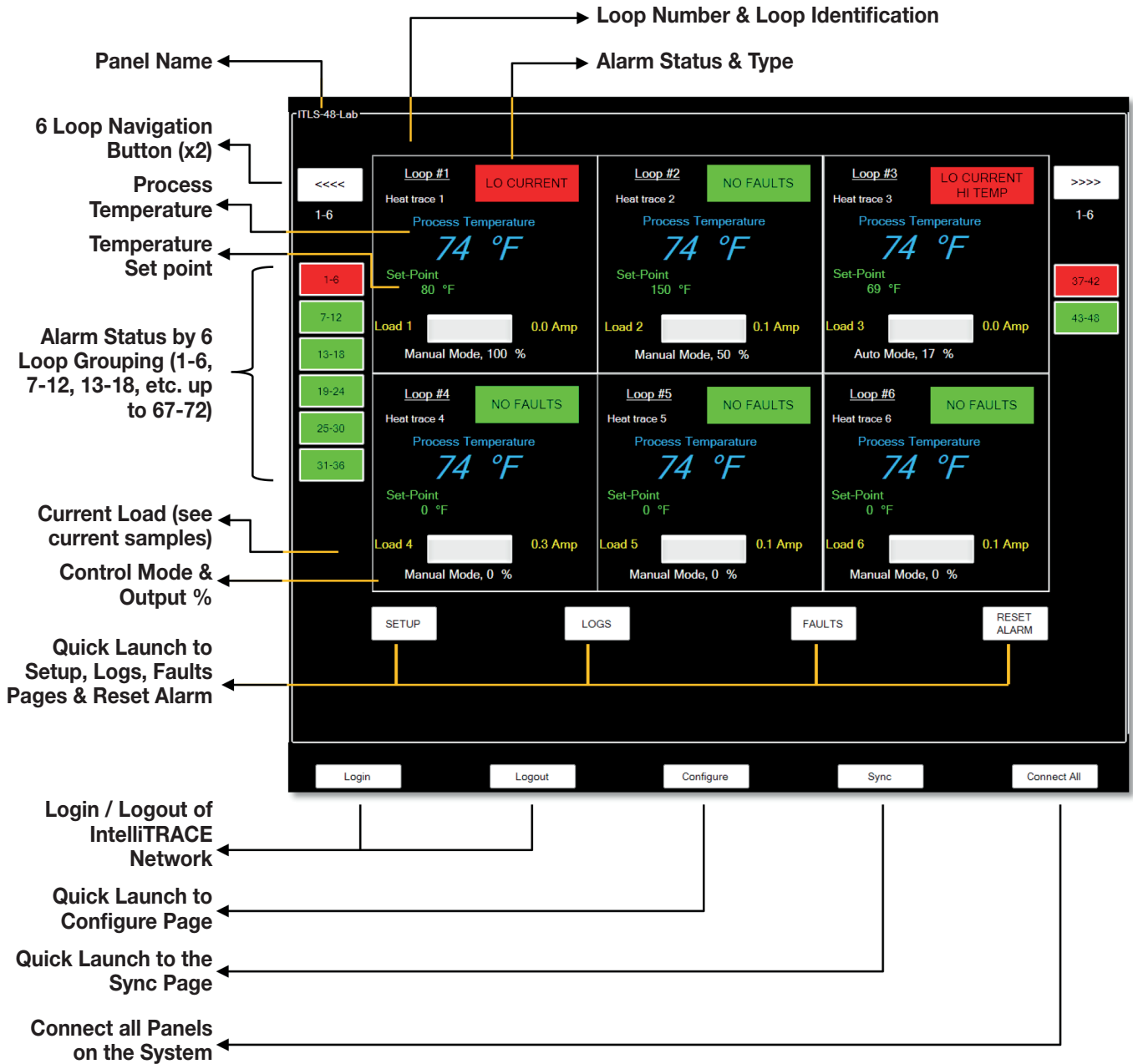

Panel List

Panel List on the right is a concise listing of all control systems (or panels) within the entire IntelliTRACE network. This provides an efficient means to navigate to any system (panel) on your network.

Additionally, network communication status is visually understood based on the color of the system (panel) name in the list.

Grey: Panel is not communicating on the network.

Green: Panel is communicating on the network, no alarms.

Red: Panel is communicating on the network, alarms present.

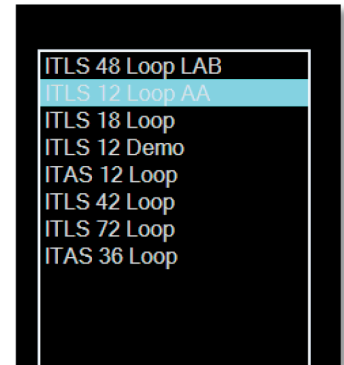

PC Requirements

When downloading IntelliTRACE to a desktop or laptop PC, the following are the suggested minimum computer requirements:

- Windows 2000/XP/7/8, 32/64 Bit
- 500 MHz CPU
- 2GB RAM
- At least one unused 10-Base-T or 10/100-Base-T Ethernet port
- Color SVGA monitor (1024 x 768 minimum)

IntelliTRACE Supervisory Controller Installation

- Run the IntelliTRACE program Setup Wizard.
- Read and accept the agreement
- Complete installation of the IntelliTRACE program by following the prompts.

Terminology Note:



When a Base Panel is combined with an Extension Panel, this is often referred to as a “System”. Therefore, throughout this manual, the terms “Panel” and “System” are typically interchangeable.

Planning Consideration:



Local programming as well as circuit monitoring and management are accomplished by the IntelliTRACE touchscreen computers. These HMI’s (Human Machine Interface) have a 72 circuit maximum capacity. Therefore, if you have an area within your facility which exceeds 72 circuits, you will need to split those circuits across multiple “panels” or “systems”.

System Configuration

Initiate IntelliTRACE Panel Network

Before you can utilize IntelliTRACE Supervisory Software, you must first follow these steps:

1. Connect IntelliTRACE panels to your network & power them up.
2. From **each** panel or system touch screen computer that is on your system, record the following communication details:
 - Modbus Address
 - IP Address (slave ID)
 - Port Number

This detail is found on the **COMMS** Page on the ITLS or ITAS Panel. See Figure 1:

Be sure that the **Modbus Type** is RTU over TCP

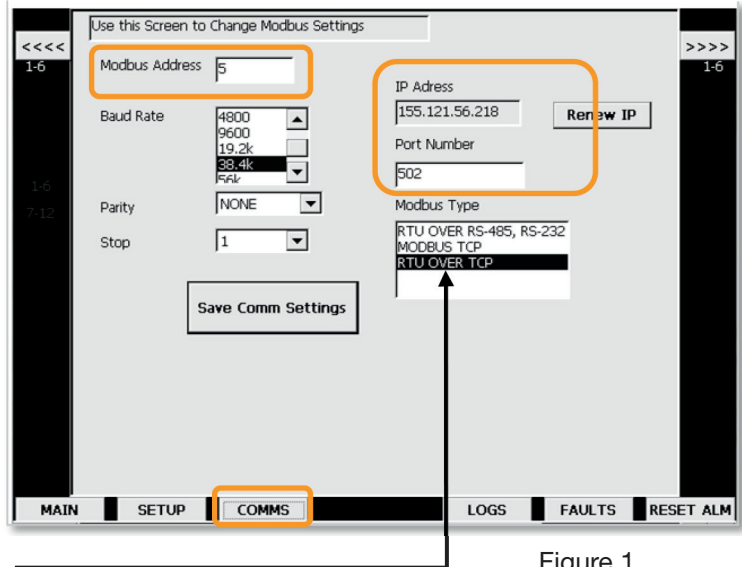

Figure 1

Refer to Chromalox Installation Manual PK497 for complete Panel setup instructions.

Planning Your IntelliTRACE System

Take the time to properly plan your system. In addition to the communication details for each “panel”, you will need to organize your circuits into groups which make sense for your facility. For your convenience, a table is provided with this manual to capture communication, naming, circuit setting and parameter value information. See the sample below:

Planning Your IntelliTRACE Supervisory Controller System

System Data									
System Edit Form									
Panel/ System	Company	Facility/ Site	Department/ Area	Panel Name (Must be unique)	Number of Loops	See COMMS on each Panel			Name of Fac
						Port Number	IP Address	Modbus Address	
1	Chromalox	Lavergne	Physical Plant	Panel 1	6	502	155.224.44.019	1	
2	Chromalox	Lavergne	Test Lab	Panel 2	48	502	155.224.44.020	2	
3									

Setpoints, Tuning & I/O Mapping Tab

Date:		Setup Form → Setpoints Tab											
Total Ckt. Count	Panel Name (Control up to 72 Circuits)	Circuit Name	Temp. Setpoint:	High Temp. Alarm:	Low Temp. Alarm:	High Current Limit:	Low Current Limit:	GFEP Max Level:	Trip?	Latch?	Control Mode	Manual Output %	
1	Panel 1 (6 ckts.)	Ckt. 1											
2	Panel 1 (6 ckts.)	Ckt. 2											
3	Panel 1 (6 ckts.)	Ckt. 3											
4	Panel 1 (6 ckts.)	Ckt. 4											
5	Panel 1 (6 ckts.)	Ckt. 5											
6	Panel 1 (6 ckts.)	Ckt. 6											
7	Panel 2 (48 ckts.)	Ckt. 1											
8	Panel 2 (48 ckts.)	Ckt. 2											

Construct Your IntelliTRACE System

After you have initiated the IntelliTRACE Panel Network as instructed above, you may now take the proper steps to begin to add Individual IntelliTRACE panels to your system. They will appear in the System Tree Pane on the left as well as in the Panel List on the right.

Launch the IntelliTRACE program.

You will be presented with the screen as seen in Figure 2.

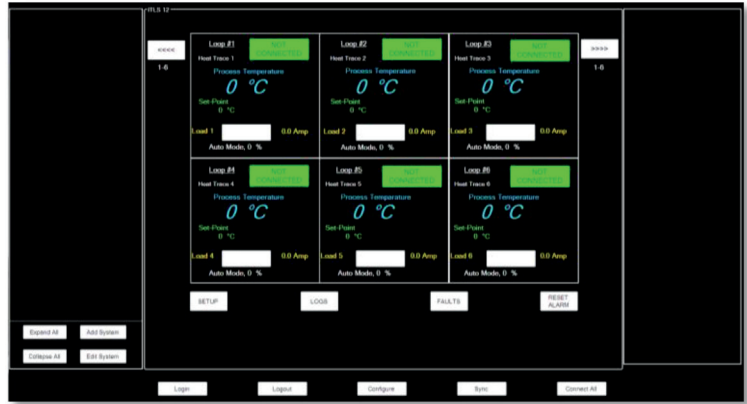

Figure 2

Security Levels & Password Screen

Before Adding or Editing a System, you must first gain access to the program.

Select the **Login** button along the bottom of the screen to gain access to the program. The Login screen will appear requesting a password. See Figure 3.

Should you wish to logout of the system, simply select the **Logout** button.

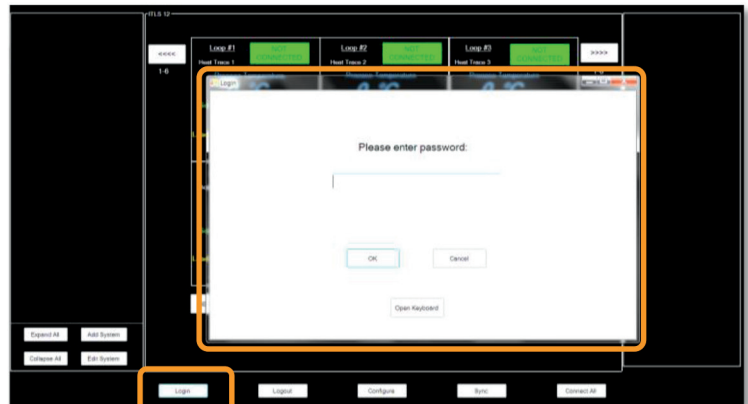

Figure 3

Initial factory set passwords and their pre-defined accessibility & rights for the below levels of Security are:

<u>Level</u>	<u>Title</u>	<u>Code</u>	<u>Accessibility/Rights</u>
4	Manager	999	All pages, all passwords & all Setpoints editing
3	Engineer	55	All pages, Engineer password & all Setpoints editing
2	Supervisor	20	Setpoints, Tuning & I/O Mapping Tabs editing
1	Operator	100	Setpoints Tab. Temperature Set Point editing

To change these passwords, access the Application Setup window by pressing the Configure Button at the bottom of the Main Screen.

Enter the appropriate password and then hit **OK** to continue.

Adding Systems

After logging into the program with the appropriate security level, you may now begin to design and / or edit your IntelliTRACE system.

If you wish to ADD a system, select the **Add System** button in the bottom left of the screen. The **System Edit** form window appears.

See Figure 4.

You will be prompted to fill in the Naming, Loop Count and the Communication Details that you gathered for each panel that you wish to add to your system.

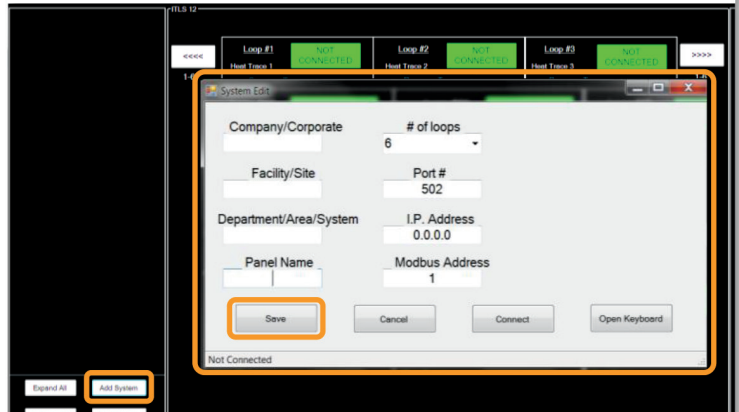

Figure 4

System Edit & Naming Requirements:

1. Please note that each “PANEL NAME” must be a unique name throughout your entire system.
2. For the “# of Loops”, you **must** select the circuit count by using the drop down button. If you manually enter the circuit count, the system will not recognize your entry.
3. The **I.P. Address** and the **Modbus Address** must match what was recorded from the respective Panel **COMMS** Page in **Figure 4**.



Select the **Save** button when you are satisfied with this System Edit form data.

The IntelliTRACE screen looks the same as it did when you first installed the program except for the entry of your new System (or Panel).

See the new entry in both the **System Tree Pane** on the left and the **Panel List** on the right in Figure 5:

Although this new System (Panel) is on your network, you are not able to communicate with it or program/change it until you **Connect** to this System (Panel).

At this point you may continue to **Add** more Systems (Panels) to your IntelliTRACE network or confirm communication and begin to program each System as you add them.

To add more systems, simply repeat the **Adding Systems** procedure above.

To confirm communication and begin to program each System, go to the **Connecting Systems** section.



Figure 5

Connecting Systems

To program, edit or monitor a System (Panel) that you have successfully added to your IntelliTRACE network, you must first **Connect** to this System.

There are three ways to have the IntelliTRACE Supervisory Controller connect to your Panel (System) network:

1. Select the System (Panel) that you wish to edit or program from either the System Tree Pane on the left or from the Panel List on the right. A fully expanded System Tree is represented in Figure 6:



Recall from the System Navigation section above that the System Tree may be fully or discretely expanded or collapsed by selecting the appropriate buttons within the system network at the bottom of the System Tree Pane.

Select the **Edit System** button found in the bottom of the System Tree Pane.

The **System Edit** window appears. Select the Connect button in the bottom of the System Edit window. See Figure 7.

2. Select the **Connect All** button at the bottom of the Main Screen. This connects all Panels (Systems) that have been properly saved to your network.
3. Select the **Connect to All Systems on Startup** checkbox that is found on the Application Setup page. This page is presented when you select the **Configure** button at the bottom of the Main Screen. See **Configuring Your System** section for more detail.

If the settings are correct, the **System Connected** window appears which confirms the proper communication settings.

Alternatively, should the communication data not match, a **Communication Error** window will be presented. In this case, double check the communication settings on the panel and retry the connection steps. See Figure 8.

Once you have made a successful connection between the IntelliTRACE Supervisory Controller and the targeted System(s)/Panel(s), you are now ready to monitor, program or edit the circuits.

You may now close the System Edit window (X in upper right corner). To program or edit individual circuits, proceed to the **Programming & Editing** section.

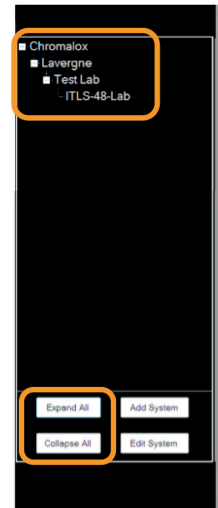

Figure 6



Figure 7

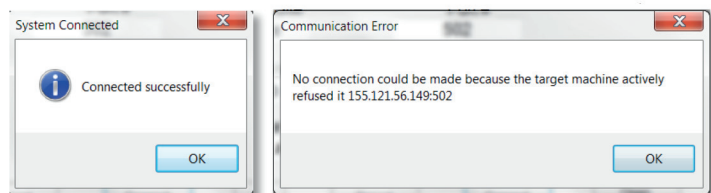

Figure 8

Programming & Editing

To program or edit circuits, select the **SETUP** button at the bottom, left side of the Main Screen. You will be presented with the Setup Form. See Figure 9.

Setpoints Tab

The Setpoints Tab contains input cells for the following Settings for Each Loop: See Figure 10.

- Customized Naming of each Loop
- Process Temperature Set Point
- High & Low Temperature Alarm Limits
- High & Low Current Alarm Limits
- Maximum allowable GFEP (Ground Fault Equipment Protection) Alarm Limit
- Trip & Latch Enabled / Disabled (Output permission) upon GFEP Violation
- Output Control Mode behavior, whether Automatic (AUTO) or Manual
- Manual Output Control Load Percentage (if enabled)
- Loop Output Override (Enable or Disable Each Loop)

Additionally, there exists a “Global Setting” within the first Loop of each 6 Loop group.

- Apply Globally Setting



Figure 9

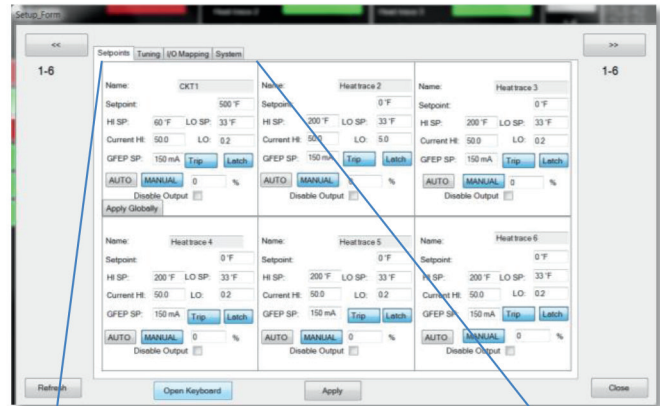

Figure 10

Definitions for each of the Setpoints Tab input Cells:

- Customized Loop Name
- Process Temperature Set Point
- High & Low Temperature Alarm Limits
- High & Low Current Alarm Limits
- Maximum allowable GFEP Limit
- Latch/Trip Output upon GFEP Violation
- Output Operation
- Manual Output Load Percentage
- Apply Settings Globally
- Disable Loop Output

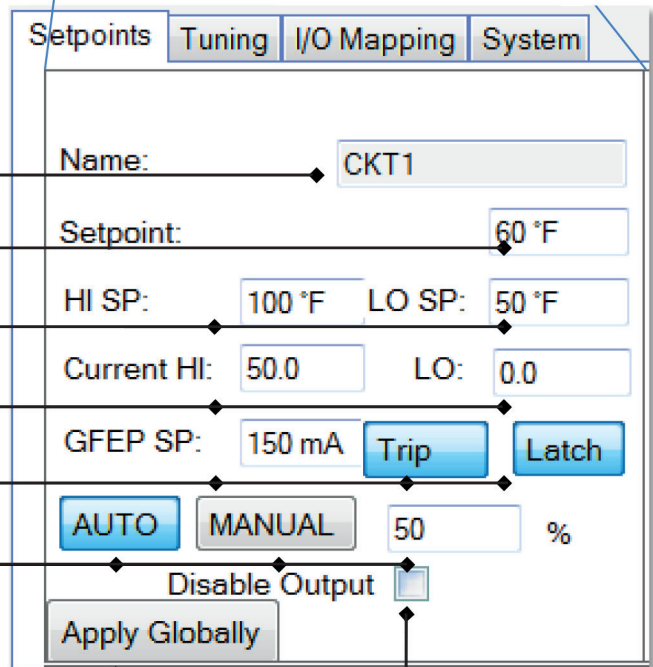

Figure 11

Definitions for each of the Setpoints Tab Input Cells:

Name:	Customize the Name of this individual circuit or loop
Setpoint:	Process Temperature Set Point (degrees F or C)
HI SP:	High Temperature Alarm Limit (degrees F or C)
LO SP:	Low Temperature Alarm Limit (degrees F or C)
Current HI:	High Current Alarm Limit (Amps)
Current LO:	Low Current Alarm Limit (Amps)
GFEP SP:	Maximum Allowable Leakage Current setpoint (milliamps)
Trip (GFEP):	Enabled: If the GFEP limit is met, the output will be 0%.
	Disabled: If the GFEP limit is met, the output is unaffected.
Latch (GFEP):	Enabled: If the GFEP limit is met, the alarm condition will remain until it is manually cleared.
	Disabled: If the GFEP limit is met, the alarm condition will be cleared once the GFEP variable is less than the GFEP setpoint
Auto/Manual:	Select <u>Auto</u> if you wish the Output behavior to be a function of a PID Algorithm or ON/OFF Control (See Tuning Tab for selection)
	Select <u>Manual</u> if you wish the Output to be driven by a pre-determined Output Percentage. Enter the desired % output.
Disable Output:	Select this check box if you wish to turn off or disable this loop.
Apply Globally:	This allows the user to copy all of the settings or Loop Parameters from Loop #1 to all other available Loops within the same Panel (System).



Parameter Value Settings

Please refer to the Appendix for all Default, Minimum & Maximum Settings



Temperature Units

The Temperature Unit setting is a selection that is typically referenced only once. It is therefore found on the System Tab. Please refer to the System Tab, which is located in the Setup Form, to access this setting.



Navigation Note

On the Main Screen and all tabs within the Setup Form, you are presented with 6 circuits at a time. To make setting changes to circuits beyond the current screen, one must select the Loop Navigation buttons in the upper right or left of each screen.

Mass Settings

Some networks have an extremely high quantity of circuits or the same parameter settings across many circuits and/or Panels (Systems). In order to make the programming process more efficient in these instances, the IntelliTRACE Supervisory Controller employs an **Apply Settings Globally** feature and a **Synchronize Settings** feature.

Apply Settings Globally

The Apply Settings Globally feature allows the user to apply settings from a single loop to all of the remaining loops within the panel (system). Within Loop #1 on the Setpoints Tab (See Figure 11), complete the input of the parameters and then select the “Apply Globally” button to mirror these settings across all loops *within* that panel (system).

Synchronize Settings

The IntelliTRACE Supervisory Controller also offers a feature which allows the user to apply the settings from one system (panel) to any or all of the remaining systems (panels) on the network. Press the Sync button at the bottom of the Main Screen to reveal the Sync Form. See Figure 12.



Figure 12

The Source List of panels is on the left and a Destination List of panels is on the right. Choose which destination panels are to receive the source settings.

The settings from Circuit #1 of the Source Panel will be applied to all of the circuits of the selected Destination Panels.

Tuning Tab

The owner has a choice on what type of Control Mode or how the output is to be operated: Auto, Manual or Off. These selections are made within the Setpoints Tab.

If "AUTO" or Automatic Control Operation is desired, then the Tuning of the Automatic Control is accomplished via the Tuning Tab. See Figure 13.

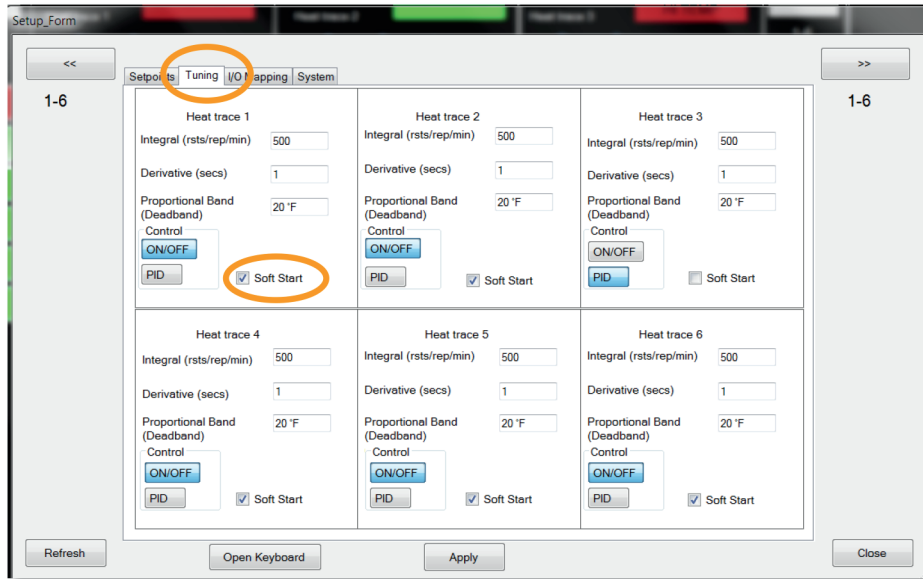

Figure 13

Control Modes: ON/OFF, PID & Autotune

- Select ON/OFF if you wish the operation of the heaters to be 100% ON when a demand for heat exists and 0% once that demand is removed. The output is ON until the Process Temperature equals the upper limit of the Deadband. The output is then turned off until the Process Temperature falls below the lower limit of the Deadband. At this point the cycle repeats. See Chart 1
- Select PID if you desire PID Control of the heaters. The owner may input his/her Integral, Derivative and Proportional Band parameters in the appropriate cells.
- The Autotune Feature exists only locally on the ITLS touch screen. If Autotune is selected, then the PID parameters will be calculated and entered by the system once the Autotune function has completed its demand profile function.

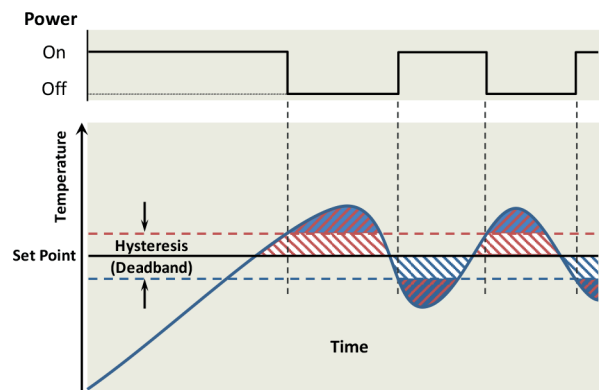

Chart 1

Soft Start Feature

The IntelliTRACE Supervisory Controller monitors and manages Chromalox control panels which are ideal for controlling Heat Trace Cable. Certain heating cables exhibit inherent current inrush in colder temperatures. This inrush can cause nuisance breaker tripping. To limit inrush current on the overall system, a proprietary Soft Start algorithm is applied during system start-up. This will ONLY occur while the operation mode is set to AUTO.

The Soft Start program will increment output % by 1% every 1 second until the desired temperature is reached or the output % achieves 100%. After the Soft Start program completes its cycle, the Control Mode of the system will either be PID or ON/OFF Control, depending what was selected by the user.

The Soft Start Program will not function if the control mode is set to Manual.

The default setting of the proprietary Soft Start Feature for each circuit is “enabled”. However, the Soft Start Feature may be disabled if so desired by the owner. The owner has the option to manage the Soft Start Feature on each circuit individually.

See Figure 13.

I/O (Sensor & Output) Mapping Tab

The IntelliTRACE Supervisory controller will facilitate the customizable I/O Mapping feature found on the ITLS & ITLSC1D2 type Heat Trace panels. *This is only available if the I/O Mapping feature on the panels themselves is enabled.* This becomes a very powerful and desirable feature when the owner needs added flexibility in controlling the circuit outputs beyond the standard single sensor input.

(This is not available in the ITAS or ITASC1D2 Models).

There are two different types of I/O Mapping: Sensor Mapping and Output Mapping.

1. Sensor Mapping is the assignment of one or more Sensor Inputs to one or more output circuits.
2. Output Mapping is the assignment of one or more Power Outputs to one or more output circuits.

Sensor (Input) Mapping and Output (Power) Mapping are accessed via the I/O Mapping Tab found within the Setup Page.

Sensor Mapping

Ambient or Line Sensing, Single Sensor

A single sensor (RTD) may be mapped (or linked) to multiple Output Circuits. This allows several circuits to be controlled by a single sensor.

Minimum, Maximum, Averaging

Several sensors may be mapped to a single output circuit. This allows a single circuit to be controlled by the Minimum or the Maximum or the Average temperature of all of the sensors mapped to that output circuit. This may be desirable on long runs or zones which realize varying temperatures or weather conditions at different times of the day.

Multiple Sensor Mapping

A single sensor may be used independently or combined with other sensors to control more than one circuit.

For Example:

The average temperature of Sensors 1, 3 & 5 is used to control Circuit 1 while simultaneously the maximum Temperature of Sensor 3, 4 & 5 is used to control Circuit 2.

Combining Sensing Types

The owner may need to have multiple Line and/or Ambient Sensing control scenarios occurring simultaneously.

For example, these may be occurring simultaneously:

- 1) Circuits 1, 2, 3, 4, & 5 are all controlled by a single RTD (Sensor 1) that is sensing the ambient temperature (Ambient Sensing)
- 2) Circuit 6 is controlled by Sensor input 2 which is strapped to a process pipe. (Line Sensing)

Sensor Mapping is accomplished within the I/O Mapping Tab found in the Setup Property Sheet. See Figure 14.

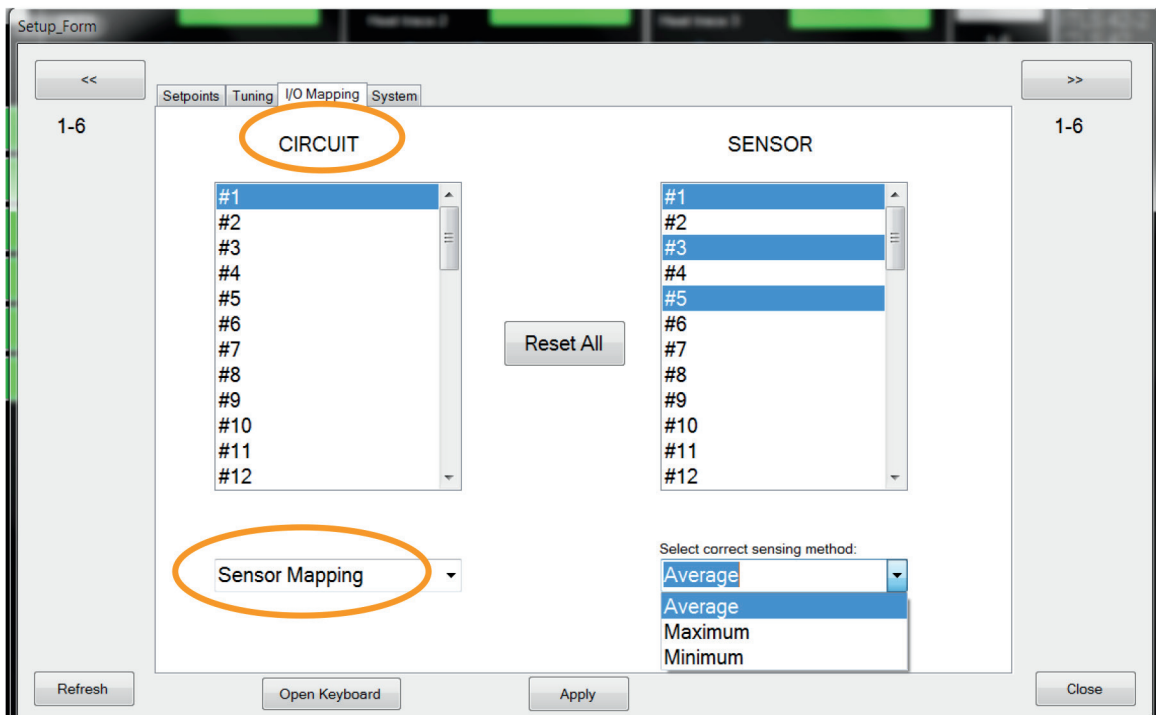

Figure 14

Output Mapping

Output Power Sensing

A single Output demand value may be mapped to multiple Circuits. This allows several circuits to be controlled by a single Output demand value.

Minimum, Maximum, Averaging

Several Output demand values may be mapped to a single output circuit. This allows that circuit to be controlled by the Minimum or the Maximum or the Average Output demand value of all of the Outputs that are mapped to that single Circuit.

Multiple Output Mapping

A single output demand value may be used independently or combined with other output demand values to control more than one circuit.

For Example:

The average output demand value of circuits 1, 3 & 5 is used to control Circuit 1 while simultaneously the maximum Output demand value of Circuits 3, 4 & 5 is used to control Circuit 2.

Output Mapping is accomplished within the I/O Mapping Tab found in the Setup Form Page. See Figure 15.

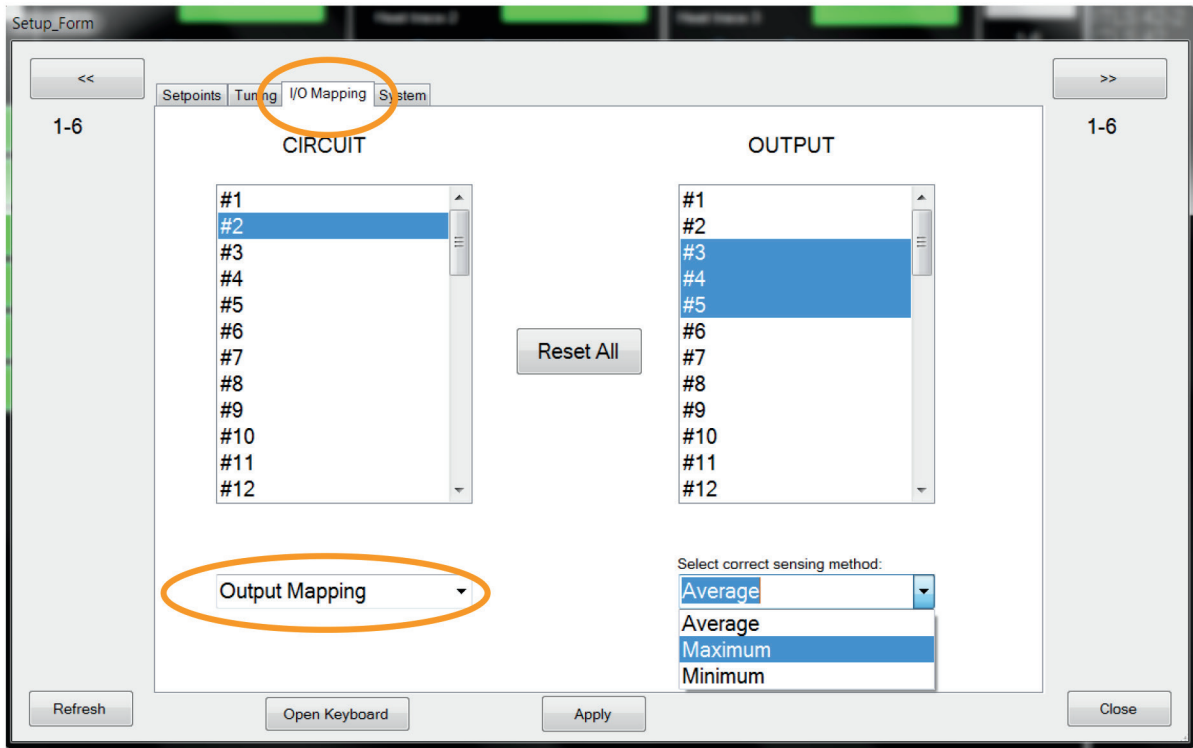

Figure 15

System Tab

Several informative items and general settings are available within the System Tab.

Here, one can enter/revise the Facility Name, Temperature Units, AutoCycle Interval & Number of Current Samples. See Figure 16.

The System Tab is only available to Manager and Engineer security levels.

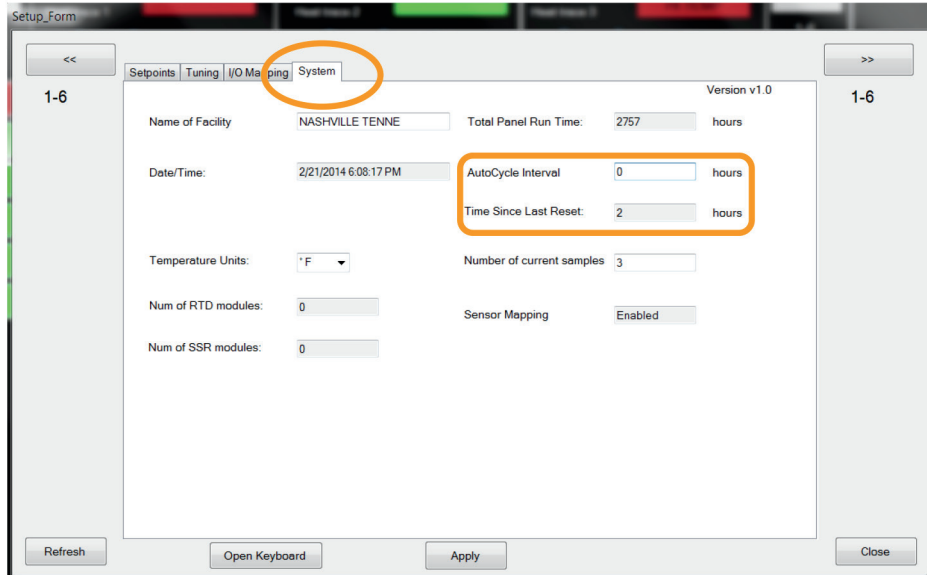

The screenshot shows a software window titled "Setup_Form" with a tabbed interface. The "System" tab is selected and highlighted with an orange circle. The window contains the following fields and values:

Field	Value	Unit
Name of Facility	NASHVILLE TENNE	
Total Panel Run Time	2757	hours
Date/Time	2/21/2014 6:08:17 PM	
AutoCycle Interval	0	hours
Time Since Last Reset	2	hours
Temperature Units	F	
Number of current samples	3	
Num of RTD modules	0	
Sensor Mapping	Enabled	
Num of SSR modules	0	

Buttons at the bottom include "Refresh", "Open Keyboard", "Apply", and "Close". The "System" tab is also circled in orange.

Figure 16

AutoCycle

During prolonged down time periods, typically during the summer months, it is advisable to intermittently exercise the loops. This exercising of the Loops is accomplished via the AutoCycle feature.

To enable the AutoCycle Feature, select an AutoCycle Interval greater than 0 hours.

The AutoCycle Feature is disabled when the AutoCycle Interval equals 0 hours.

On a sequential circuit basis, the AutoCycle feature periodically monitors system performance at intervals of 1-999 hours. The minimum and maximum values for Current Load, GFEP and Temperatures are stored. (Once the new high or low value is attained the old value is overwritten and displayed in the Autocycle Tab Text Boxes. This is only visible on the individual panels).



The AutoCycle provides a meaningful level of preventative maintenance of the system as Faults (Alarms) will present themselves accordingly. Problem areas can be addressed during non-essential operating periods.

WARNING:



It is NOT advisable to engage the Auto Cycle feature during normal operating periods. The heating cables will become fully energized for approximately 2 minutes throughout the Auto Cycle Interval which could cause undesirable temperature overshoot.

Number of Current Samples

The intelliTRACE Supervisory controller has an adjustable current sampling rate. A sample (or survey) of the current load and ground fault load on one circuit is made every 250 milliseconds. The Current Load is the average of the collected samples. The Current Load for each circuit is displayed on the Main Screen.



Increasing the number of current samples increases the accuracy of the current sample reading. However, this will increase the time required to execute the circuit reading process.

Likewise, reducing the number of current samples decreases the current reading accuracy. However, the survey process is completed faster.

Therefore, one must choose whether accuracy of this reading or the frequency of this reading is most important.

The minimum - maximum range is 3 – 100 current samples. The factory default is 50.

Configuring Your System

The last items to consider while setting up your system are included in the Application Setup Page. This page is revealed when you select the **Configure** button at the bottom of the Main Screen. See Figure 17.

These default configuration considerations include display, reporting & alarming behavior, security and system connection decisions.

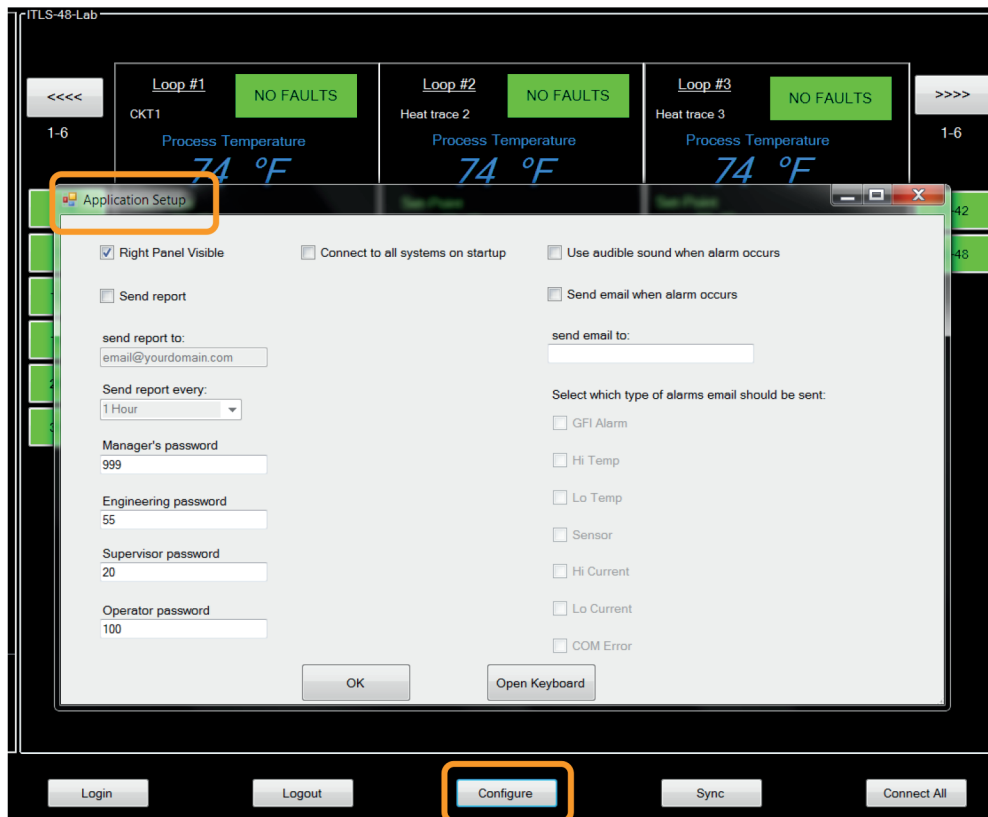

Figure 17

Display

- Right Panel Visible – Determine if you wish to have the Panel List displayed at all times.

Reporting

- Send Report: Choose whether or not reports are to be sent
- Send Report to: An event log report may be sent to an email address
- Send Report Every: (Report Frequency) – How often shall the event log report be sent?

Alarm Behavior

- Use audible sound when alarm occurs – When engaged, an audible beep will occur at the IntelliTRACE Supervisory Controller.
- Send email when alarm occurs – when selected, an email will be sent to the provided address when an alarm event occurs.
- Select which types of alarms should be sent – Choose which alarms types are valid for an email alert message.

Security

- Revise all four levels of password security

Panel (System) Connection

- Connect to all systems on startup – Automate communication connection to all systems during startup.

Event (Alarm) Log

The purpose of Event Log is to capture every alarm type and its condition with a date and time stamp. This log is itemized in the **Log Form**, which is revealed when the **LOGS** button at the bottom of the Main Screen is selected. See Figure 18.

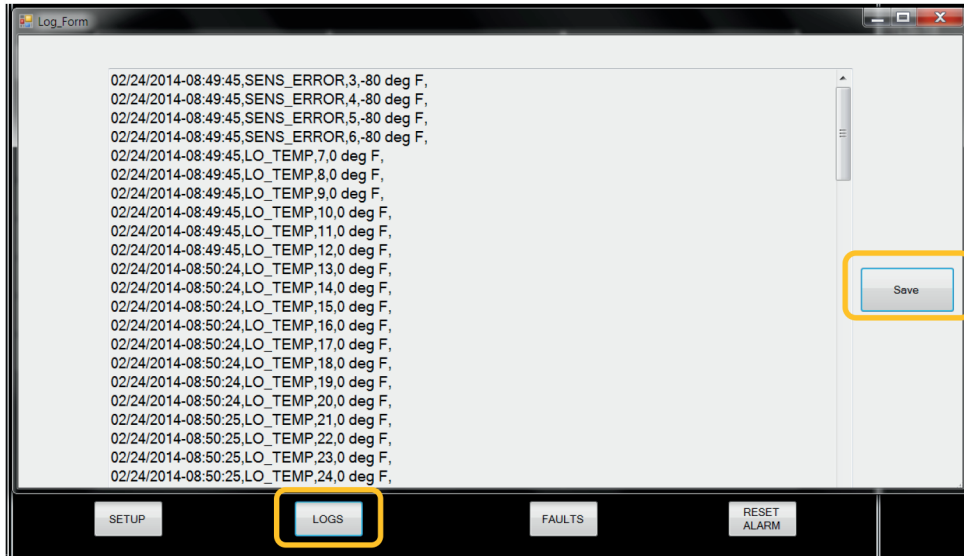

Figure 18

This log may be saved to a file. To accomplish this, select the **Save** button on the right side of the Log Form. You will be prompted with a **Save As** window. Choose the destination of your choice. See Figure 19.

The Event Log file will be saved as a CSV (comma separated value) type Text (.txt) file. This will be important if it is to be viewed or manipulated in Microsoft Excel.

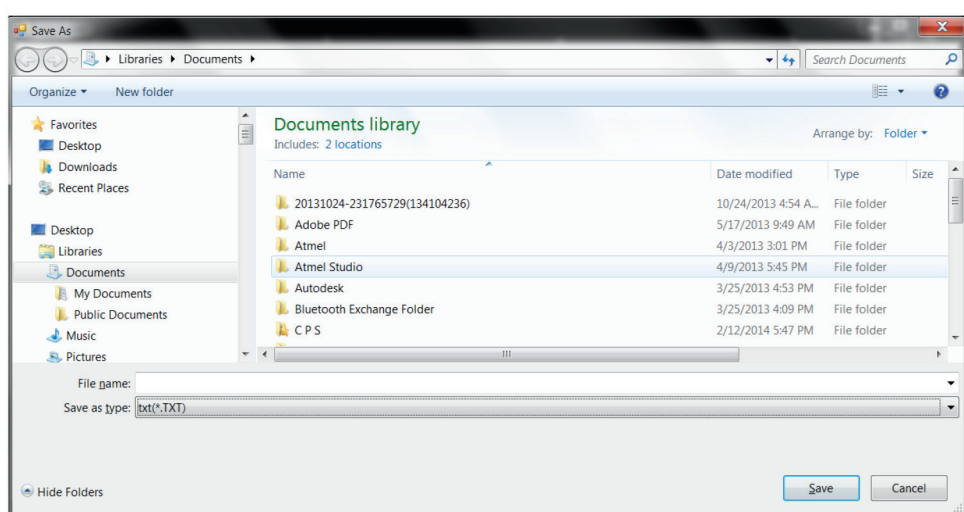

Figure 19

Faults (Alarms)

Faults within any 6 Circuit or Loop grouping are indicated by RED rectangles in the Left and Right panels on any screen. If the rectangle is GREEN, then no faults exist within that 6 Circuit grouping. Once a fault is realized within any 6 Loop grouping, one may view the individual fault loop or loops in two different ways:

1. When in the Main Menu Screen, one may navigate to the desired 6 loop grouping via the Navigation buttons found in the upper right hand or upper left hand corner. Fault conditions are illustrated within each loop window. Up to three Alarm Conditions can be illustrated for any single loop on the Main Menu Screen.
2. One may view the status of all fault conditions by selecting the **FAULTS** button located at the bottom of any screen. To navigate to the desired 6 Loop grouping, one must press the Loop Navigation buttons found in the upper right or left corner of any screen. See Figure 20.



Figure 20

Clearing Alarms

Except for a Communications and Latched GFEP Alarm conditions, all other alarms are cleared once the acceptable parameters are achieved. However, the alarm(s) may be cleared by pressing the **RESET ALARM** button found at the bottom of any screen. This has no effect on the actual readings. Therefore, unless the fault problem is resolved, the fault condition will return.

Alarm Troubleshooting

The Alarm Condition, the resultant Output and the Design Behavior for each Alarm Type can be found in Table 1 below.

Table 1

Alarm Type	Condition	Output			Design Behavior
HIGH TEMP	Sensed Temp > Hi Temp Setpoint	No change			Alarm will be cleared automatically when Sensed Temp < Hi Temp Setpoint
LOW TEMP	Sensed Temp < Lo Temp Setpoint	No change			Alarm will be cleared automatically when Sensed Temp > Lo Temp Setpoint
GFEP	Sensed GFEP Current > GFEP Setpoint	Trip	Latch		
		No	No	Output will remain at selected output %.	Alarm will be cleared automatically when sensed GFEP Current < GFEP Setpoint
		Yes	No	Output will go to 0% (OFF) while in alarm state	
		No	Yes	Output will remain at selected output %.	The Alarm condition may only be cleared with a manual RESET of the GFEP Alarm.
Yes	Yes	Output will go to 0% (OFF) until alarm is reset			
HI CURRENT (LOAD on Faults Screen)	Sensed Load Current > Hi Current Setpoint	Output will switch to Manual Mode			Alarm will be cleared automatically when sensed Load Current < Hi Current Setpoint
LO CURRENT (LOAD on Faults Screen)	Sensed Load Current < Lo Current Setpoint	No change			Alarm will clear automatically when Sensed Load Current > Lo Current Setpoint. If your output is turned OFF, GFEP and Load values will not be updated.
SENSOR	Sensor Open, Sensor Shorted, Sensor Fault	Output will switch to Manual Mode			Alarm will clear automatically when the RTD resistance is between 75.44Ω - 311.56Ω. Check if your sensor wire is not damaged and that it is properly connected to the Sensor board.
COMM	Communication Error	Output will switch to Manual Mode			Make sure that the communication cable that connects the Touchscreen computer with boards inside enclosure is properly connected and/or not broken. Press “RESET ALM” to reset this alarm.

Appendix

Below is the parameter settings chart organized by Menu Screen. It includes the default, minimum, maximum and / or the range of settings, where applicable.

Parameter	Default	Min	Max
Temperature Setpoint	0°F (-18°C)	-80°F (-62°C)	1100°F (-593°)
Hi Temp Setpoint	200°F (-93°C)	-80°F (-62°C)	1100°F (-593°)
Lo Temp Setpoint	33°F (-1°C)	-80°F (-62°C)	1100°F (-593°)
HI Current	50 Amp	0.2 Amp	50 Amp
Lo Current	0.2 Amp	0 Amp	50 Amp
GFEP	30 mA	20 mA	150 mA
Control Mode	Manual	Manual	Auto
Output %	0	0	100
PID or ON/OFF	On/OFF	PID	On/OFF
Deadband	10	2	100
Proportional Band (%)	20	1	100
Integral	8	0	100
Derivative	2	0	500
Soft Start	Enabled	Enabled	Disabled

Wiring Considerations

- The maximum distance between ITLS panel and router can be 100m. If this distance needs to be extended it would be necessary to utilize an inline repeater.
- Cable that should be used is CAT5 RJ45 Ethernet cable.
- The HMI display has 1 Ethernet port on the back of the display (see photo below).

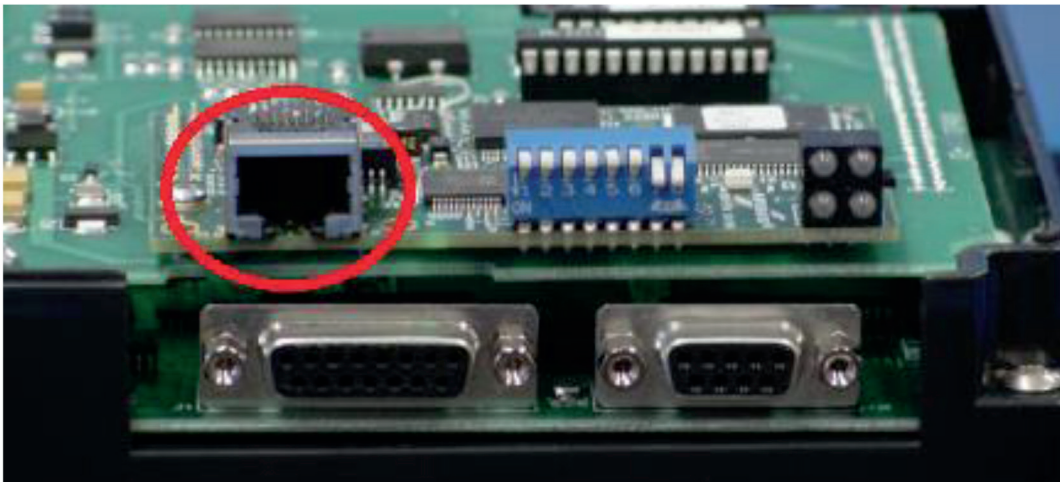

- Insert one end of the Ethernet cable into the HMI and the other end into customer's network hub or router. All HMI's must be connected the same way.
- Typically the IP address of each HMI is assigned automatically by the DHCP Host.
- Every HMI Touch Screen Computer must have different Modbus (Slave) ID and a different IP address. These are found on the ITLS or ITAS COMMs page.
- In order to communicate all HMI's and the ISC Supervisory Control system must be in the same network.

Service Contact Information

Chromalox is a global supplier, providing the highest level of customer support. If you should have questions concerning your intelliTRACE™ Supervisory Controller or intelliTRACE ITLS/ITAS control panel platforms, or need information, you may contact Chromalox at:

Corporate Headquarters Chromalox, Inc.	Controls Division Chromalox, Inc.
103 Gamma Drive Pittsburgh, PA 15238 Phone: (412) 967-3800	1347 Heil-Quaker Blvd. LaVergne, TN 37086 Phone: (615) 793-3900
Customer Service Hotline: 1-800-443-2640	

For application questions, you can:

1. Call one of our application engineers for personal assistance at 1-888-996-9258.
2. Visit the technical reference section of our website at www.chromalox.com for downloadable manuals in PDF format.

Limited Warranty:

Please refer to the Chromalox limited warranty applicable to this product at <http://www.chromalox.com/customer-service/policies/termsofsale.aspx>.

Chromalox, Inc.
1347 Heil Quaker Boulevard
Lavergne, TN 37086
(615) 793-3900
www.chromalox.com